

LIVRO - CADERNO

PROGRAMA DE ALFABETIZAÇÃO FUNCIONAL PELA TV



PRESIDENTE DA REPÚBLICA
Ernesto Geisel

MINISTRO DA EDUCAÇÃO E CULTURA
Euro Brandão

PRESIDENTE DO MOBRAL
Arlindo Lopes Corrêa

SECRETÁRIO EXECUTIVO DO MOBRAL
Sérgio Marinho Barbosa

SECRETÁRIO EXECUTIVO ADJUNTO DO MOBRAL
Odaléa Cleide Alves Ramos

(Preparada pela Fundação Movimento Brasileiro de
Alfabetização CETEP/SEDOC)

F981 Fundação Movimento Brasileiro de Alfa-
betização. GEPED.
Programa de alfabetização pela TV;
livro caderno. Rio de Janeiro, 1978.
244 p. ilustr. 27 cm.

1. Alfabetização funcional via TV.
I. Título.

78-97

cdd:374.27
cdu:371.687

Ministério da Educação e Cultura
Fundação Movimento Brasileiro de Alfabetização — MOBRAL

LIVRO CADERNO

PROGRAMA DE ALFABETIZAÇÃO FUNCIONAL PELA TV

Nome do aluno _____

Rio de Janeiro
1979

Aula 1

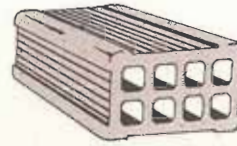
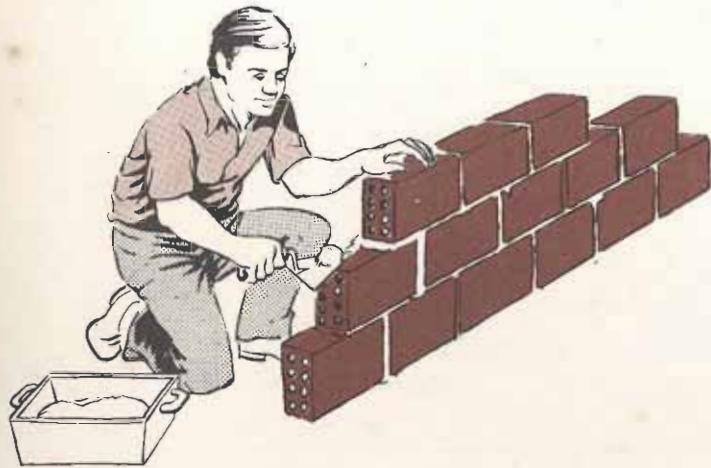

tijolo

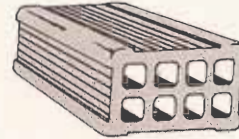
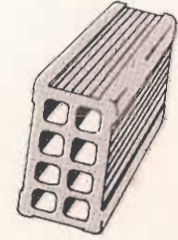

tijolo

tijolo

ti_____

tijolo

lote

tijolo

loja

lata

bola

jogo

tijolo

jipe

tijolo

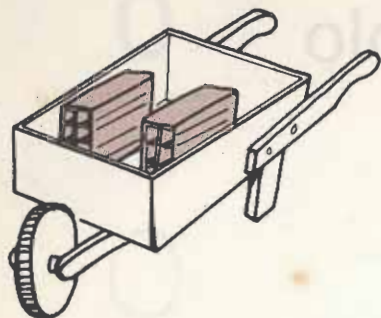

2

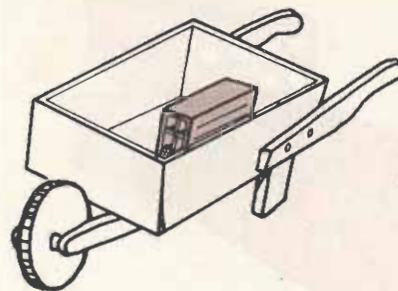

1

- 2 - 2

- _____

- 1 - 1

- _____

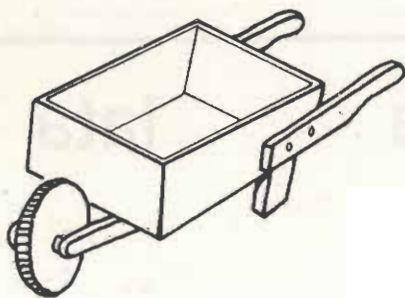

0



2

- 0 - 0

- _____



1

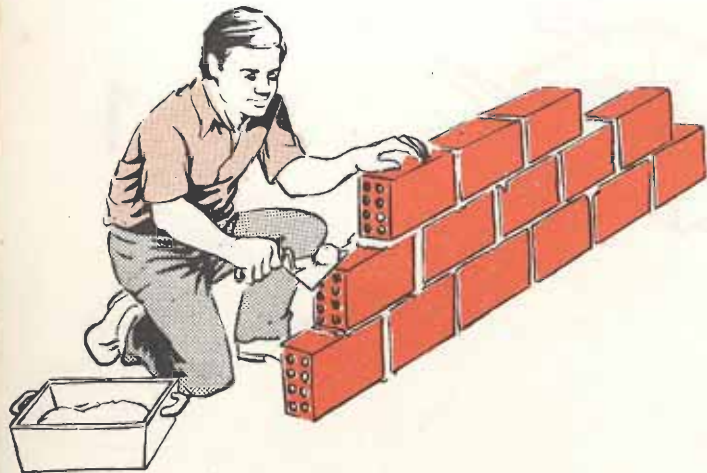

tijolo

tijolo

tijolo

tijolo

ti

tijolo	loja	lata
jogo	tijolo	jipe
tijolo	lote	bola

0

1

2

0

1

2

0

1

2



1



2

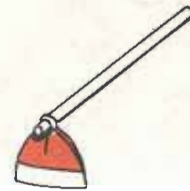

2

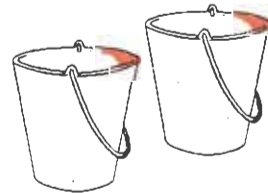

1

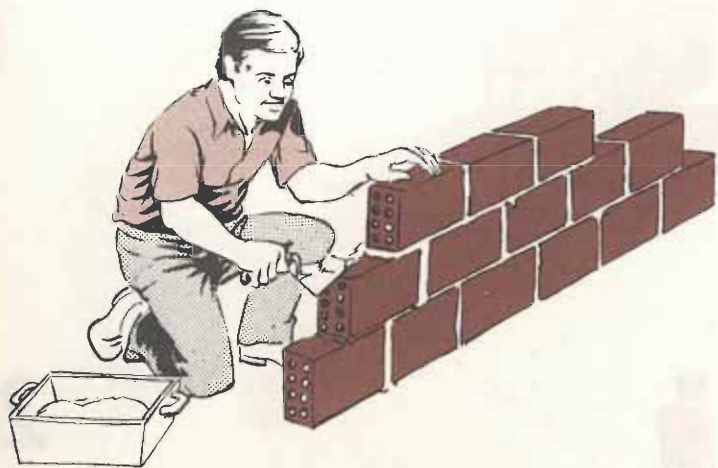

tijolo

ti jo lo

ti jo lo

ti jo lo

ta te ti to tu

ta te ti to tu



teto

teto

teto

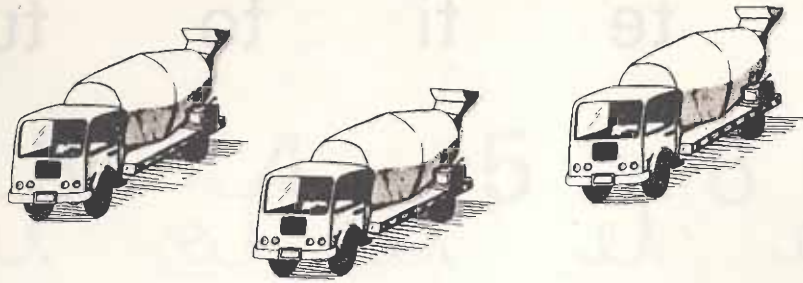

3

3

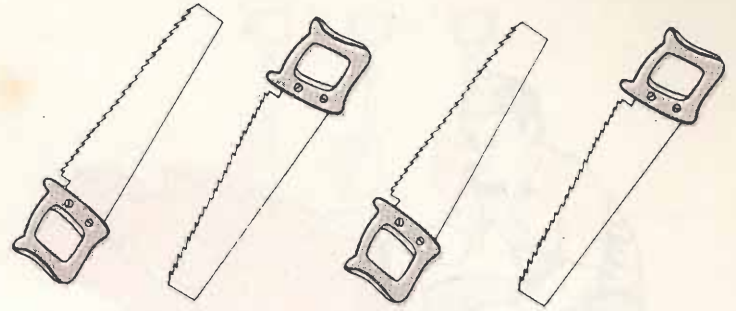

4

4

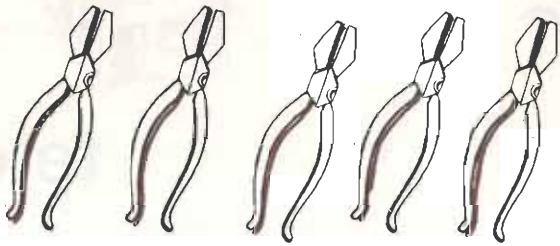

5

5

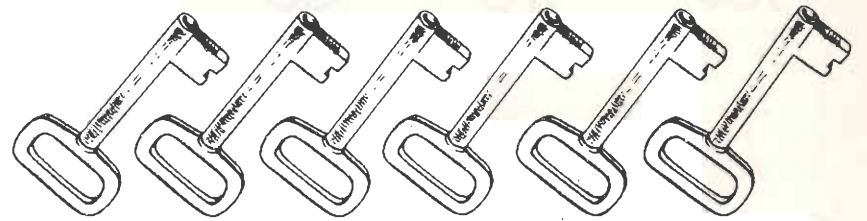

6

6

ta te ti to tu

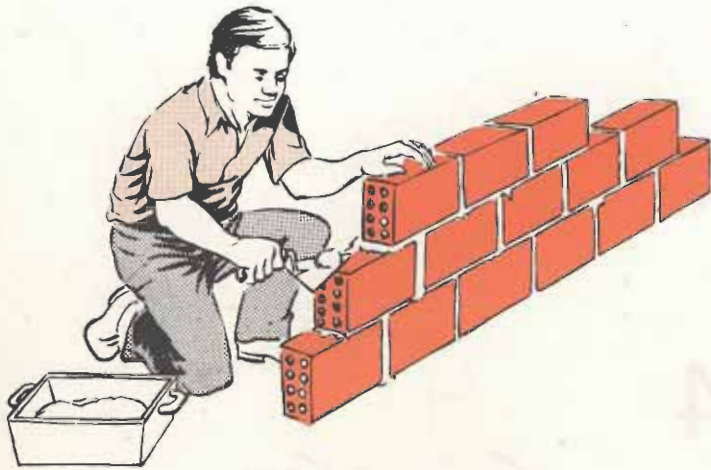

ta te ti to tu

ta

ti jo lo



tatu

teto

ti jo lo

tatu

teto

ti jo lo

3

4

5

6

3

4

5

6

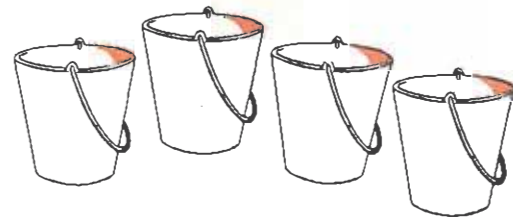
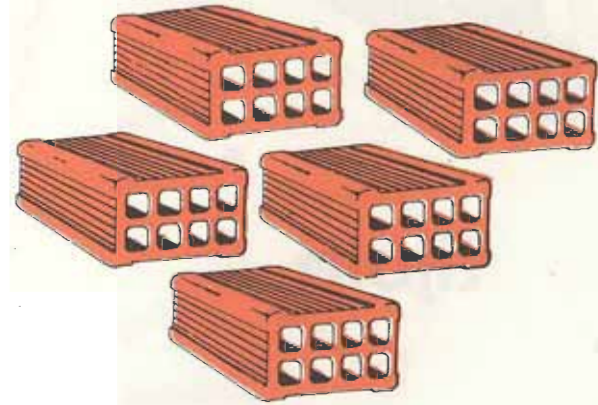
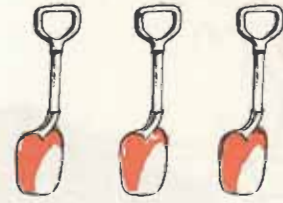

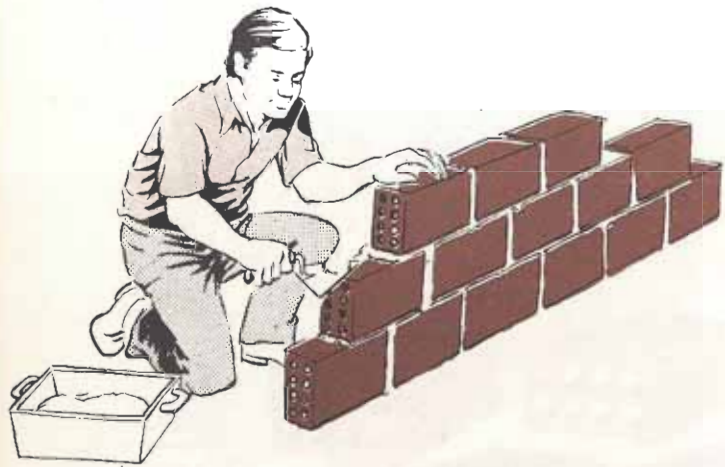

tijolo

ti jo lo

ta te ti to tu

tatu



teto



teto

tatu

ta te ti to tu

ja je ji jo ju

ja je ji jo ju



juta

jato

juta

jato



Tito

Tito



$$1 + 1 = 2$$

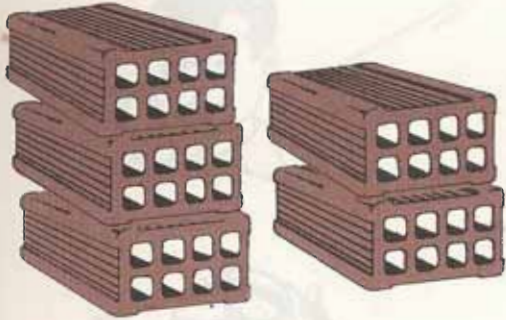

$$3 + 2 = 5$$

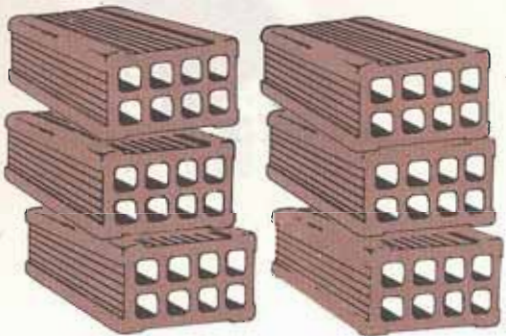

$$3 + 3 = 6$$

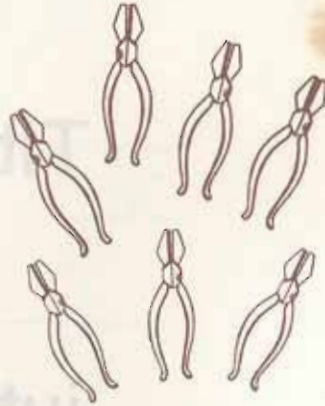

7

7

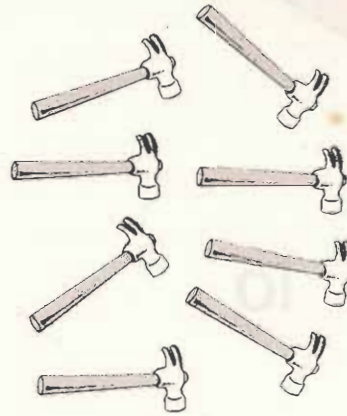

8



9

9

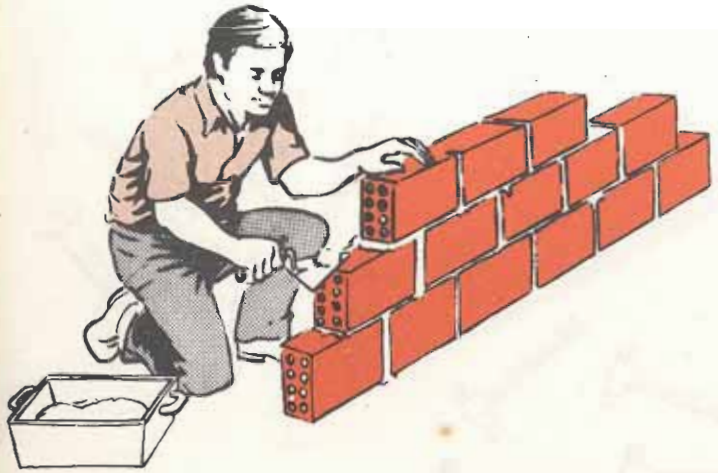

Tito



juta



teto



tatu



ti jo lo

ja je ji jo ju

ja je ji jo ju

ja _____

tatu juta tato

Tito teto

7

7

8

8

9

9

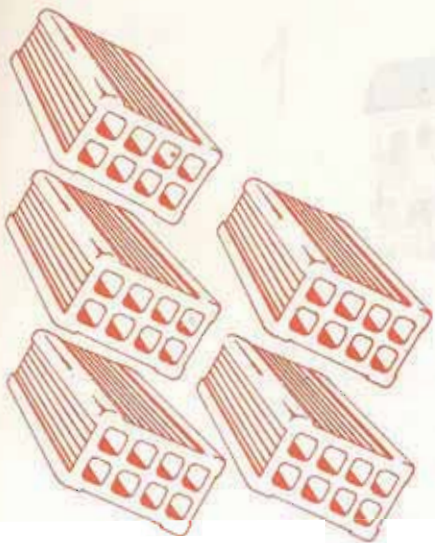

$$3 + 2 = \underline{\hspace{2cm}}$$

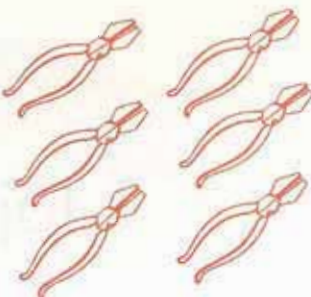

$$3 + 3 = \underline{\hspace{2cm}}$$



$$4 + 1 = \underline{\hspace{2cm}}$$



Aula 4

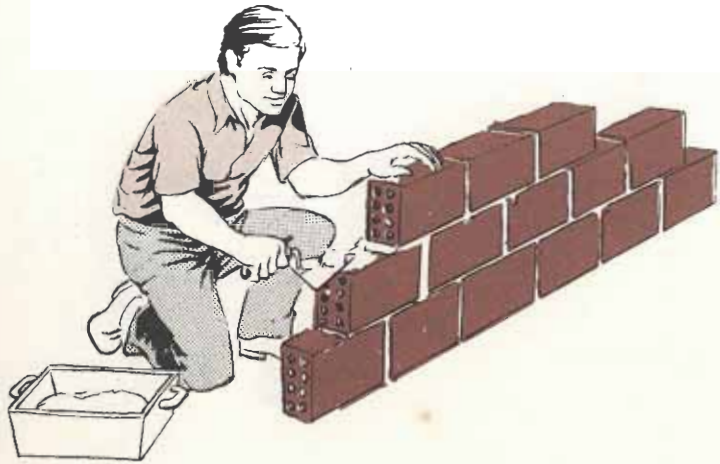

a e i o u

a e i o u

ti jo lo

la le li lo lu

la le li lo lu

la le li lo lu

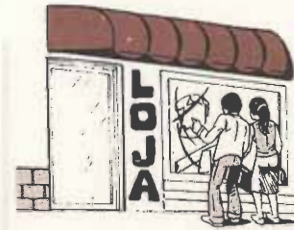

loja

loja



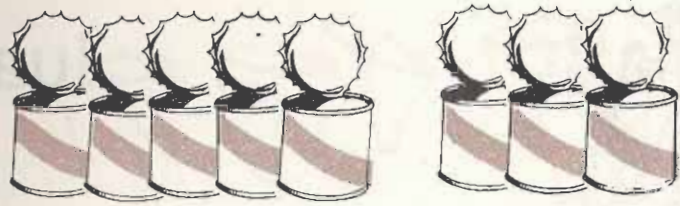

$$5 + 3 = 8$$

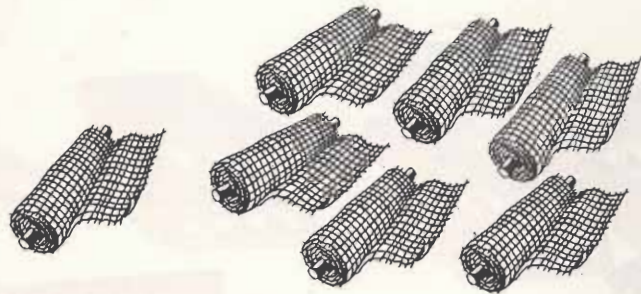

$$1 + 6 =$$

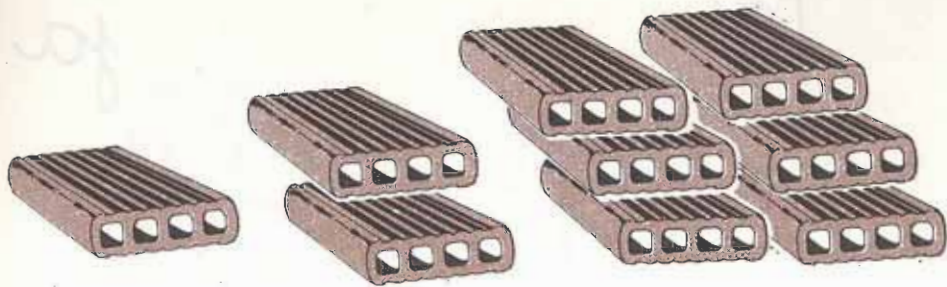

$$1 + 2 + 6 =$$

$$\begin{array}{r} + 5 \\ + 3 \\ \hline 8 \end{array}$$

$$\begin{array}{r} 1 \\ + 6 \\ \hline \end{array}$$

$$\begin{array}{r} 1 \\ 2 \\ + 6 \\ \hline \end{array}$$

Aula 4

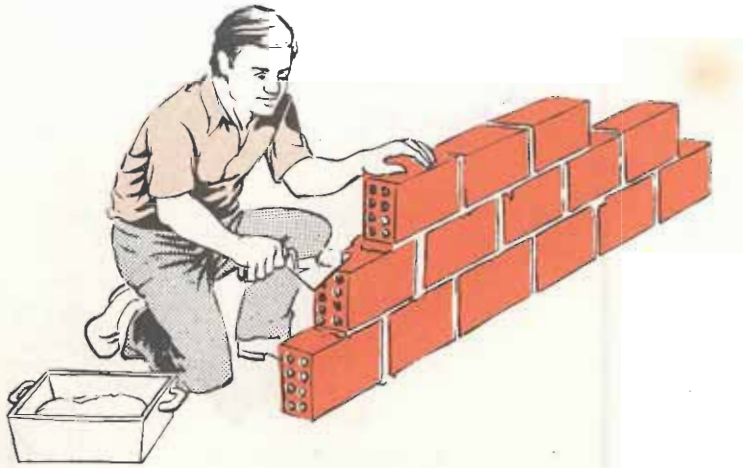

lua

lata

luta

la le li lo lu

la le li lo lu

la le li lo lu

a e i o u

a e i o u

Ti

ja



lei

ta

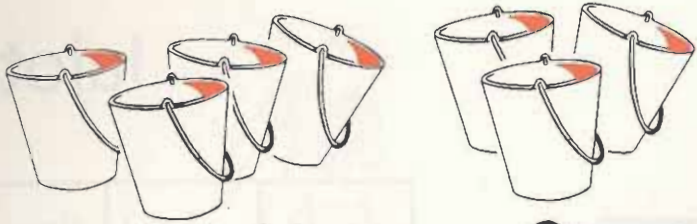

$$4 + 3 = 7$$

$$\begin{array}{r} 4 \\ + 3 \\ \hline 7 \end{array}$$

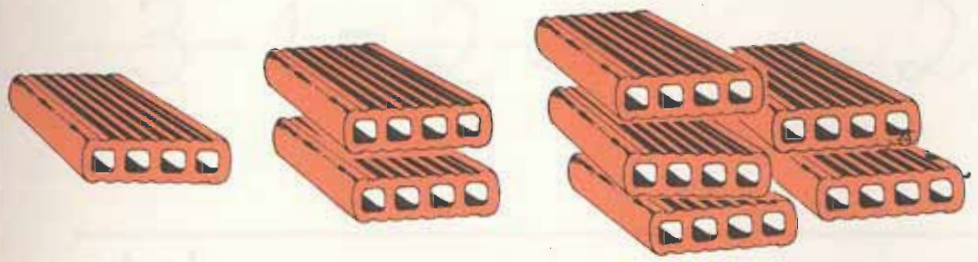

$$1 + 2 + 5 =$$

$$\begin{array}{r} 1 \\ 2 \\ + 5 \\ \hline \end{array}$$

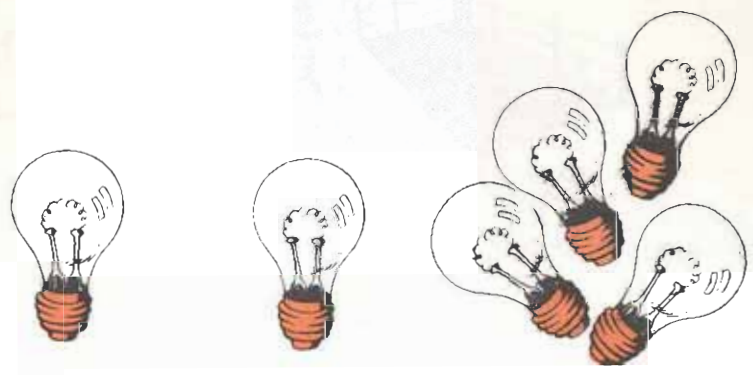

$$1 + 1 + 4 =$$

$$\begin{array}{r} 1 \\ 1 \\ + 4 \\ \hline \end{array}$$

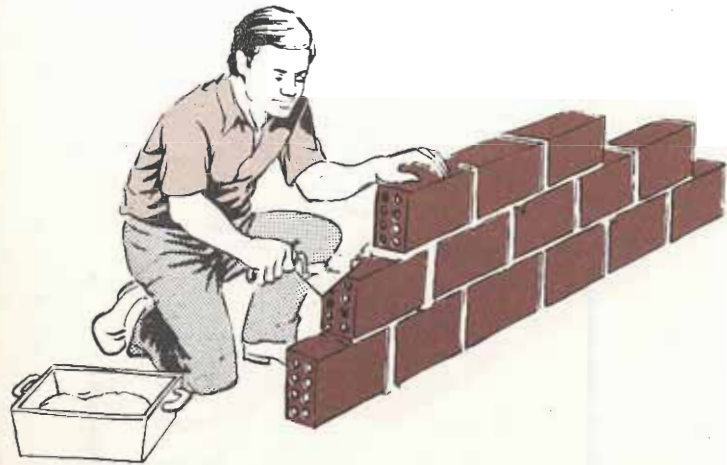

tijolo

ti jo lo



la jo ta

lajota



lo te

lote

ti	ta	ti		
jo	ja	je		
lo	la			
	a			u

Tito já lê.



$$3 - 1 = 2$$

$$\begin{array}{r} 3 \\ - 1 \\ \hline \end{array}$$

2



$$2 - 2 = 0$$

$$\begin{array}{r} 2 \\ - 2 \\ \hline \end{array}$$

0

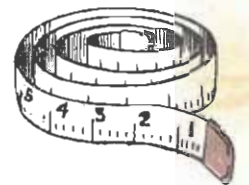
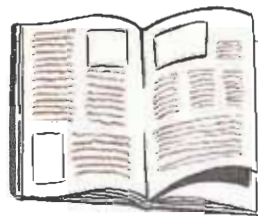
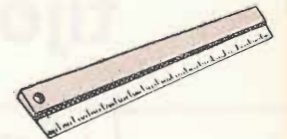
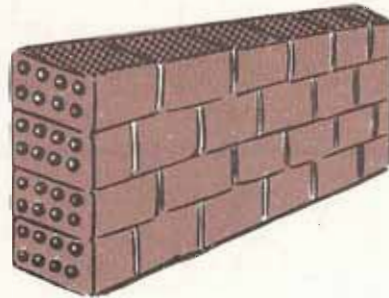
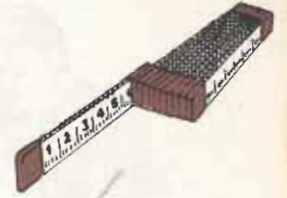

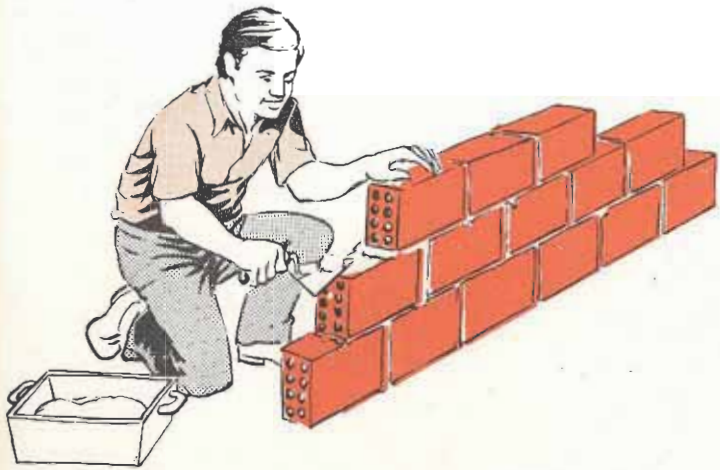

la jo ta



lajota

tijolo

tijolo



lei te

leite



Tito

ti jo lo



tijolo



jaula

Tito já lê.

Tito já lê.

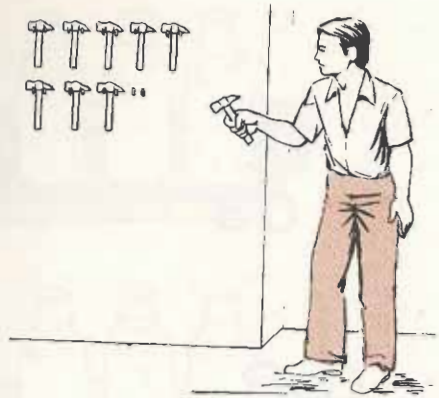

$$\begin{array}{r} 9 \\ - 1 \\ \hline \end{array}$$

$$9 - 1 = 8$$

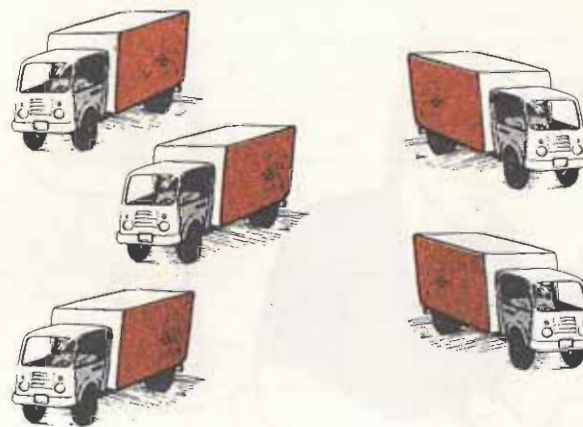

$$\begin{array}{r} 5 \\ - 2 \\ \hline \end{array}$$

$$5 - 2 =$$

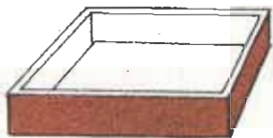

$$\begin{array}{r} 3 \\ - 3 \\ \hline \end{array}$$

$$3 - 3 =$$

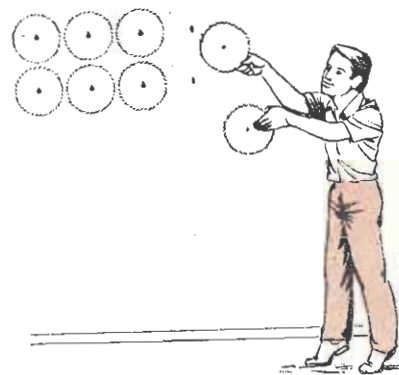

$$\begin{array}{r} 8 \\ - 2 \\ \hline \end{array}$$

$$8 - 2 =$$



comida

comida

comida

co

co mi da

co mi da

co	cola	pacote
mi	miolo	milho
da	data	toda



3



3

$$3 + 3 =$$

6

$$2 \times 3 =$$



2



2



2



2

$$2 + 2 + 2 + 2 =$$

$$4 \times 2 =$$



comida

comida

comida

co mi da

co mi da

tijolo	teto	mola	tijolo
comida	cola	comida	toda

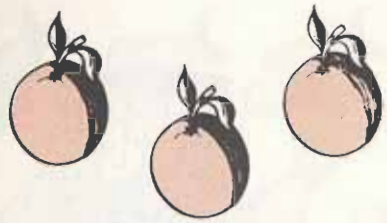

3

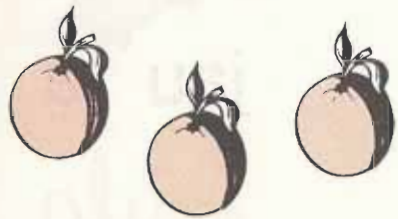



$$3 + 3 + 3 =$$

9

$$3 \times 3 =$$



$$4 + 4 =$$

$$\times =$$

$$2 + 2 + 2 =$$

$$\times =$$



comida

co mi da

ca co cu

ca co cu



co la

cola

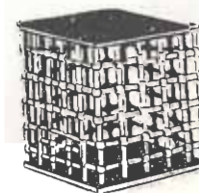

jau la

jaula



ja ca

jaca



to ca

toca

Léo come a jaca.

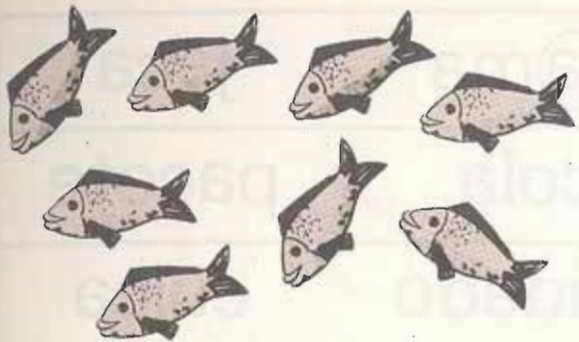

8



4

4

8

÷

=



6



2



2



2

6

÷

=



ca	ca <u>ma</u>	jaca
co	co <u>la</u>	pacote
cu	cu <u>idado</u>	cu <u>íca</u>

ca

co

cu

ca

co

cu



toca

toca



coco

coco



ma



la

Léo come a jaca.

Léo come a jaca.



8



2

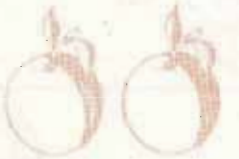

2



$$8 \div 4 =$$



$$8 \div 2 = 4$$



$$6 \div 2 = 3$$





co mi da

ca co cu

ma me mi mo mu

ma me mi mo mu

mala	
<i>mala</i>	_____
tomate	
<i>tomate</i>	_____
Ema	
<i>Ema</i>	_____

Ema come tomate.



$$0 + 0 = 0$$

$$2 \times 0 = \underline{\quad}$$

$$1 + 1 + 1 = 3$$

$$3 \times 1 = \underline{\quad}$$

$$1 + 1 = 2$$

$$2 \times 1 = \underline{\quad}$$



mala

ma la

ma me mi mo mu

meia

mei a



ma me mi mo mu

Ema come tomate.



to mate

Ema come tomate.



li ma

$$1 + 1 + 1 + 1 = 4$$

$$4 \times 1 = \underline{\quad}$$

$$0 + 0 + 0 + 0 = 0$$

$$4 \times 0 = \underline{\quad}$$

$$1 + 1 + 1 + 1 + 1 = \underline{\quad}$$

$$\underline{\quad} \times \underline{\quad} = \underline{\quad}$$

$$3 \times 0 =$$

$$6 \times 1 =$$

$$9 \times 1 =$$

6

9

0



co mi da

ca		co	cu	
ma	me	mi	mo	mu
da	de	di	do	du
a	e	i	o	u

da de di do du

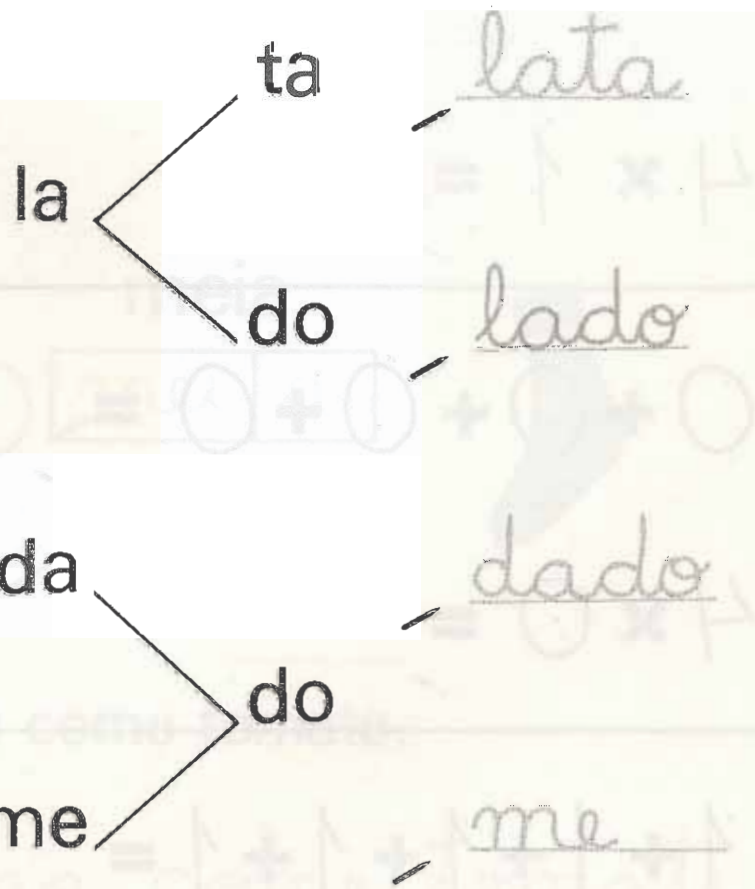

Dalila tomou mate.

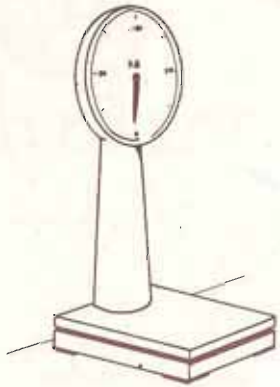

2 kg



4 kg



co mi da

me dida
lado

medida

melado

da
ma ta

data

mata

da de di do du

ma me mi mo mu

da de di do du



dado



moeda

Dalila tomou mate.

Dalila tomou mate.

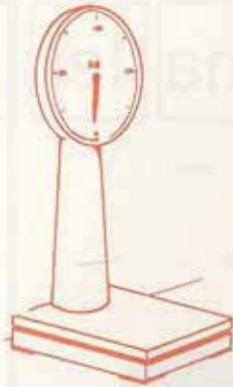

9 kg



3 kg

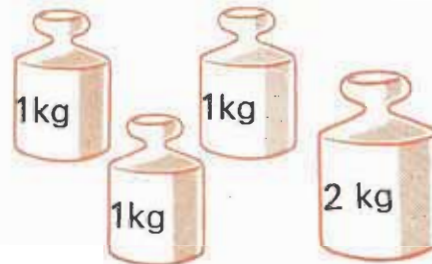
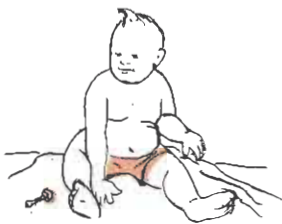

tijolo

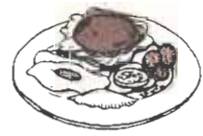

comida

ta ma lei la da ja te lo

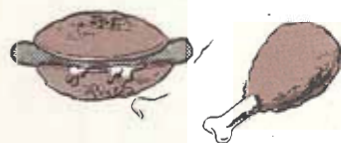
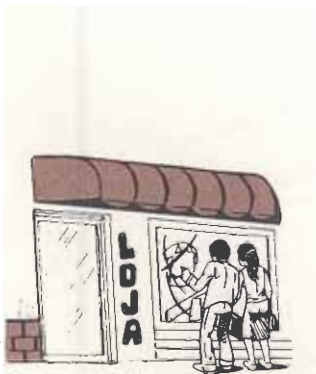

co da

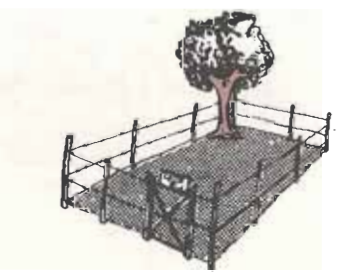

lo



a

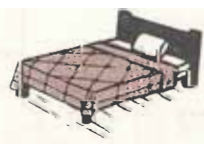

ma



comida ao Tito . deu Dalila

$5 + 3 = \underline{\quad}$

$$\begin{array}{r} 5 \\ + 3 \\ \hline \end{array}$$

$7 - 4 = \underline{\quad}$

$$\begin{array}{r} 7 \\ - 4 \\ \hline \end{array}$$

$8 \div 2 = 3$

$6 + 3 = 5$

$5 - 2 = 4$

$3 \times 0 = \underline{\quad}$

$4 \div 1 = \underline{\quad}$

$1 \times 5 = 9$

Aula 10

tijolo



comida

ma
te

to

mo
ma

la

toma
comi

da

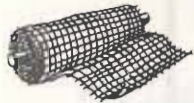

caiu Lia cama. da

$$2 + 4 = \underline{\quad}$$

$$\begin{array}{r} 2 \\ + 4 \\ \hline \end{array}$$

$$9 - 8 = \underline{\quad}$$

$$\begin{array}{r} 9 \\ - 8 \\ \hline \end{array}$$

$$3 + 1 = 8$$

$$4 \times 2 = 6$$

$$3 \times 3 = \underline{\quad}$$

$$9 \div 3 = \underline{\quad}$$

$$6 \div 2 = 4$$

$$2 \times 3 = \underline{\quad}$$

$$8 \div 4 = \underline{\quad}$$

$$7 - 1 = 3$$



remédio

cama	comida	remédio
cola	remédio	remo
lua	tijolo	remédio

remédio

remédio

re

mé

dio

re

mé

dio



10 10

$$10 + 10 = 20$$



$$10 + 10 + 10 = \underline{\quad}$$



$$10 + 10 + 10 + 10 = \underline{\quad}$$



remédio



cama cola comida



lajota tijolo loja

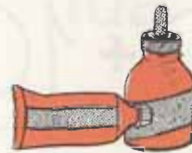

remo lua remédio

remédio

re mé dio



20



30



5



10



8



$$10 + 10 =$$



10

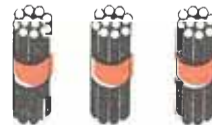

Four horizontal lines for writing the answer to the addition problem.



rato
ra ramo
ralo raio

remédio

re mé dio

ra re ri ro ru

ra re ri ro ru

ra _____



rato

rato

O remédio matou o rato.

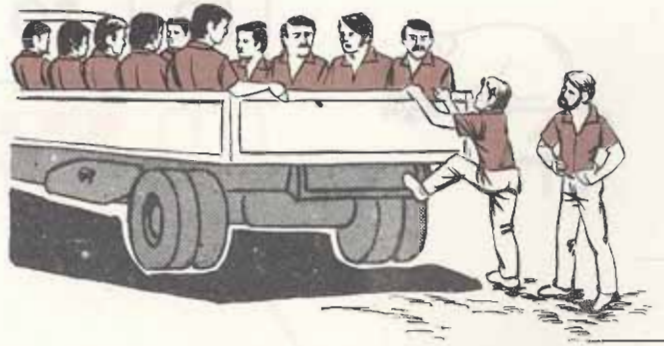

$$10 + 2 = 12$$



$$20 + 5 = \underline{\quad}$$



$$40 + 9 = \underline{\quad}$$



$$30 + 6 = \underline{\quad}$$

$$30 + 6 = \underline{\quad}$$



$$20 + 3 = \underline{\quad}$$

$$20 + 3 = \underline{\quad}$$



remédio



ra

to



ra

mo

ra	ra	ramo
re	reta	remo
ri	rima	rica
ro	roda	rolo
ru	rua	ruído

O remédio matou o rato.



11

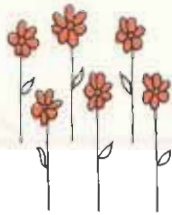

13

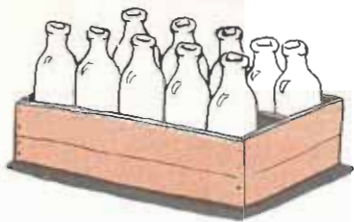

16



30

7

30

+

7

=

37



20

+

4 =



40

+

8 =



remédio

re mé dio

re mé dio



rádio

rádio

re cado
de

recado

ri co
o



Cuidado, Rui!

A rede cai.



h



h



h

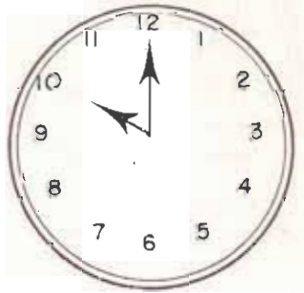

h



remédio

re	<u>ra</u>	_____	_____	<u>ru</u>
mé	_____	<u>me</u>	_____	_____
dio	<u>da</u>	_____	_____	_____
	<u>a</u>	_____	_____	_____



roda

radio

dio

Cuidado, Rui!
A rede cai.

Cuidado,

a





9h



h



6 h

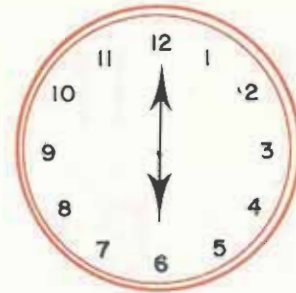

8 h



3 h

Aula 14



sa pa to

sa se si so su

sa se si so su

sapato

sapato

sapato

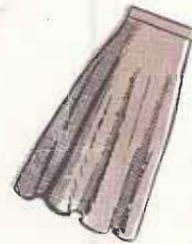

saia

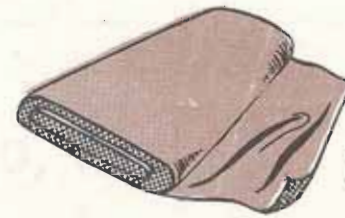

seda

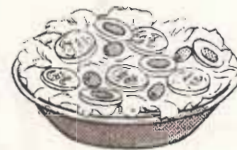

salada



suco

MAIO

D	S	T	Q	Q	S	S
	1	2	3	4	5	6
7	8	9	10	11	12	13
14	15	16	17	18	19	20
21	22	23	24	25	26	27
28	29	30	31			



sapato

sapato

sapato

sala

sapato

sapato

sola

saúde

sapato



sa

sacola



su

suco



saia



sujo

MAIO

D S T Q Q S S

1 2 3

7 9

14 15 18

21 26

28 31



sa ú de

so pa

po te

sapato

pote de sopa

sa se si so su

pa pe pi po pu

pote de sopa

pa pe pi po pu

d	u
	

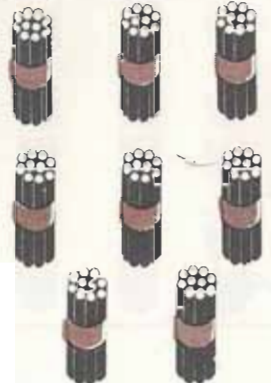
d	u
	



$$30 + 40 =$$



$$50 + 40 =$$

Aula 15



sapato

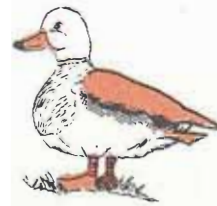

to

pa

letó



pa	<i>pa</i>	_____
pe	<i>pe</i>	_____
pi	<i>pi</i>	_____
po	<i>po</i>	_____
pu	<i>pu</i>	_____





pa



so

la



O médico cuida da tua saúde.

d	u
 	

d	u
  	



$$50 + 10 = \underline{\quad}$$

$$20 + 60 = \underline{\quad}$$



su a do

pe te ca

sa pa to
sa pa to



sítio

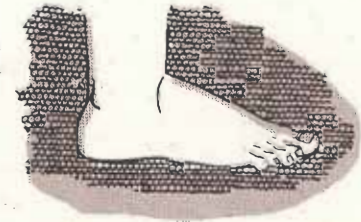

pé

sa se si so su

pa pe pi po pu

ta te ti to tu

a e i o u

sujou a Tito do sola pé.

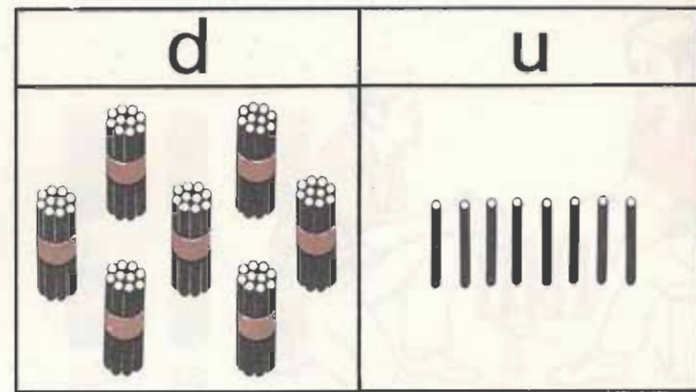
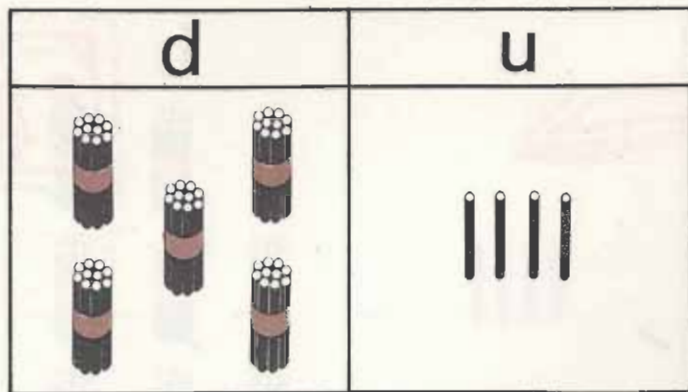

$$60 + 7 = \underline{\quad}$$

$$80 + 3 = \underline{\quad}$$



sapato

sapato

sa	sapo	salada
pa	mapa	palito
to	tomate	mato



de

salada

tomate.

comeu

Paulo

Paulo

= 5 + 0 d

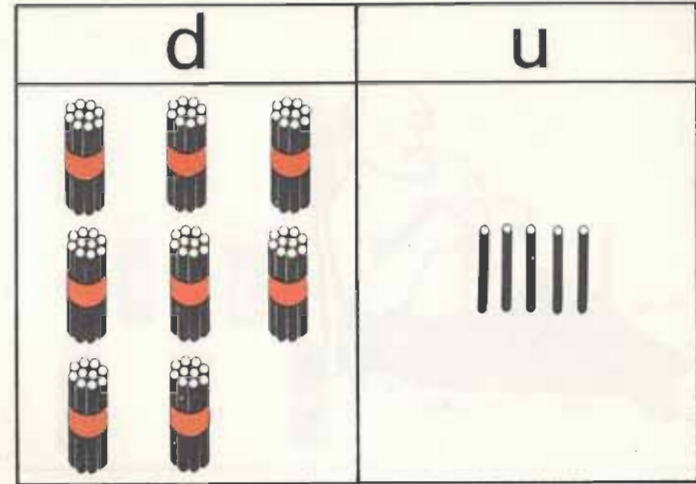
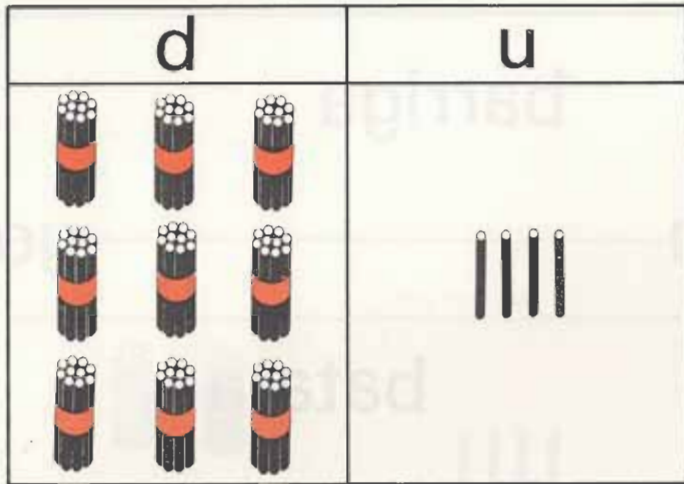

$$80 + 6 = \underline{\quad}$$

$$70 + 7 = \underline{\quad}$$

$$90 + 3 = \underline{\quad}$$



barriga

barriga

bala

gola

batata

barriga



bela

barriga

ba rri ga



barriga

Rute comeu muito.
Sua barriga doeu.

d	u
	

3

4

d	u
	



$$20 + 8 = \underline{\hspace{2cm}}$$

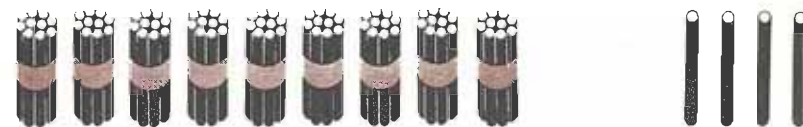

$$90 + 4 = \underline{\hspace{2cm}}$$



barriga

ba	ba la	sábado
rri	corrida	sorriso
ga	gado	ruga

barriga



barriga

Rute comeu muito.
Sua barriga doeu.





Rute

Sua

d	u
	

6 8

d	u
	



40 6

$$40 + 6 = \underline{\quad}$$



$$50 + 5 = \underline{\quad}$$



barriga

ba rri ga

ba be bi bo bu

ba be bi bo bu



bebida

bebida





tabela

BEBIDAS	Cr\$
Doce de Leite	1100
Receita de Leite	1700
Cacau	2100
Mel	2300
Doce de Leite	2100
Doce de Leite	2650







bule

Tome mate do bule.
É uma boa bebida.

d	u
	
	

12
+ 14

$$12 + 14 = \underline{\hspace{2cm}}$$

d	u
	
	

65
+ 13

$$65 + 13 = \underline{\hspace{2cm}}$$



ba rri ga

ba be bi bo bu

ba be bi bo bu



ca be lo



bi ca





ca bi de



be bi da





O mate já acabou.
Rute pede o bule.



d	u
	
	

46

+ 2

d	u
	
	

25

+ 13

62

+ 4

87

+ 11

57

+ 2

73

+ 16

Aula 19



ba rri ga

ba be bi bo bu

rra rre rri rro rru

rra rre rri rro rru

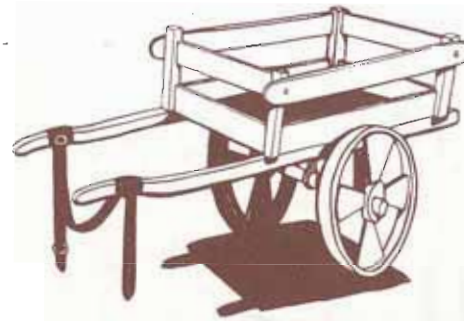

carreta



carreta





barraco



barraco



A terra caiu da carreta.
Sujou a rua toda.



d	u
	

d	u
	



$$\begin{array}{r} 38 \\ -13 \\ \hline \end{array}$$

d	u
	

d	u
	

d	u
	

$$\begin{array}{r} 87 \\ -24 \\ \hline \end{array}$$

d	u
	



barraco

barraco



jarra

ba rri ga



serrote

rra

rra

rre

rre

rri

rri

rro

rro

rru

rru

Belita acabou a comida.
Ela bebeu o suco da jarra.

Belita

Ela

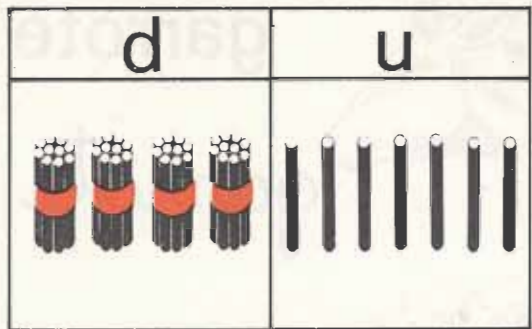

$$\begin{array}{r} 94 \\ -11 \\ \hline \end{array}$$

$$\begin{array}{r} 79 \\ -32 \\ \hline \end{array}$$

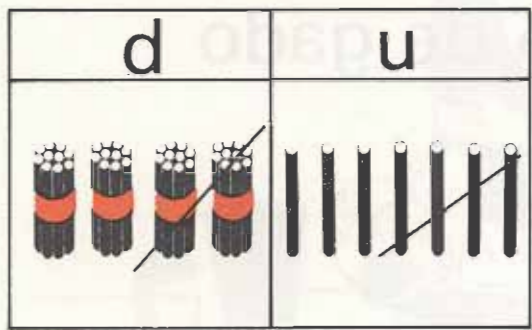

$$\begin{array}{r} 47 \\ -24 \\ \hline \end{array}$$

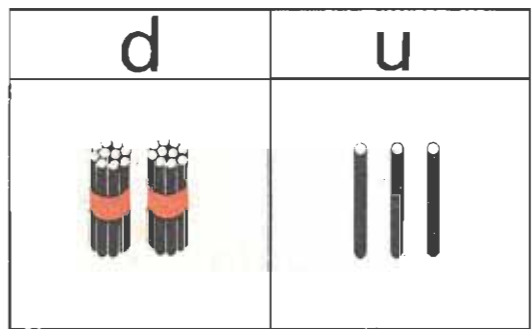

$$\begin{array}{r} 56 \\ -53 \\ \hline \end{array}$$

$$\begin{array}{r} 65 \\ -44 \\ \hline \end{array}$$

Aula 20



barriga

ba rri ga

ga go gu

ga go gu



gado

gado



garrote

garrote

rodeio de gado



lata de goiabada

Dei uma corrida até a sala.

Comi toda a goiabada da lata.

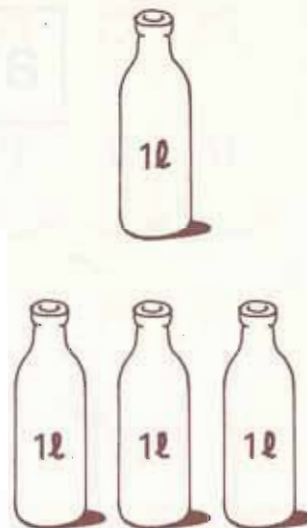

Lia bebeu _____ de leite.



a mi go

amigo

ga rro te

garrote

ba rri ga



pegada



lago

ba be bi bo bu

rra rre rri rro rru

ga go gu

a e i o u

Beto amarrou o garrote e caiu.
Ele sai do rodeio de gado.

Beto

Ele



5 ℓ



4 ℓ



2 ℓ



1 ℓ



Léo bebeu _____ de leite.

remédio



sapato

barriga



correio



selo



Belita comeu muito.

Sua _____ doeu.

O _____ já deu o remédio.

Ele cuidou da _____
de Belita.

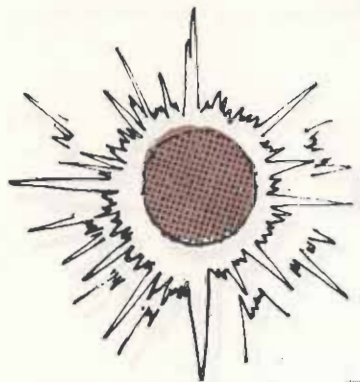

$$\begin{array}{r} 7 \\ + 12 \\ \hline \end{array}$$

h



h

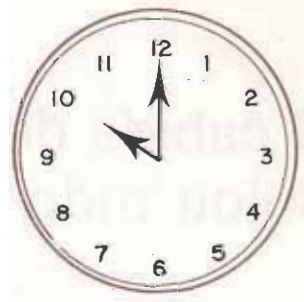
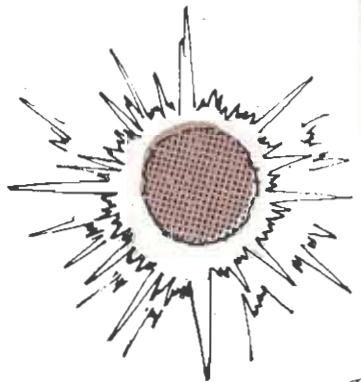

$$\begin{array}{r} 10 \\ + 12 \\ \hline \end{array}$$

h



h

remédio



sapato

barriga



bule

selo



burro

paletó



roda de carreta

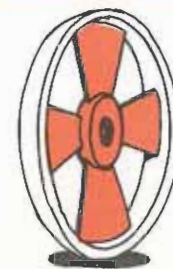

cabide de roupa



O cabide de roupa caiu.
Sujou tudo de lama.

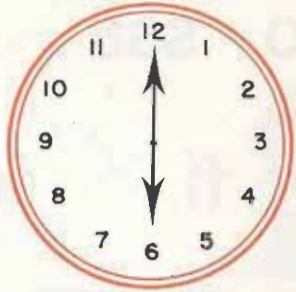
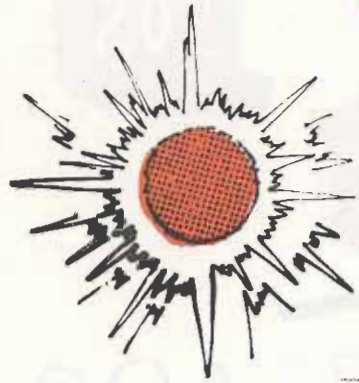

$$\begin{array}{r} 6 \\ + 12 \\ \hline \end{array}$$

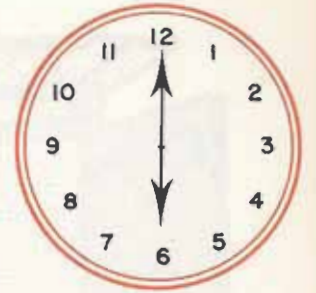

h

h

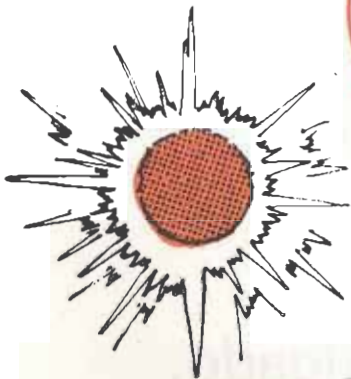

$$\begin{array}{r} 11 \\ + 12 \\ \hline \end{array}$$

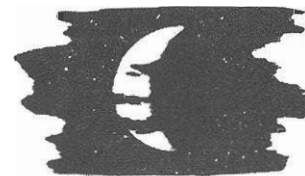

h

h



fossa

fossa

fossa

fo ssa

fa fe fi fo fu



fí ga do

figado

fo go

fogo

Felipe come bife de fígado.
Ele pede a salada de batata.



$$20\text{ l} + 5\text{ l} + 1\text{ l} = \underline{\quad} \text{ l}$$

$$\begin{array}{r} 20 \\ 5 \\ + 1 \\ \hline \end{array}$$



$$65\text{ kg} - 20\text{ kg} = \underline{\quad} \text{ kg}$$

$$\begin{array}{r} 65 \\ - 20 \\ \hline \end{array}$$

Aula 22



bife	sopa	fossa
selo	fossa	massa
foto	missa	fossa

fossa

fo ssa

fa fe fi fo fu

fa fe fi fo fu

fogo



fogo

ferro



ferro

Lola apaga o fogo.
Ela come o seu bife.

Lola

Ela

$$33 \text{ kg} + 14 \text{ kg} + 21 \text{ kg} = \underline{\quad} \text{ kg}$$

$$\begin{array}{r} 33 \\ 14 \\ + 21 \\ \hline \end{array}$$

$$78 - 23 = \underline{\quad}$$

$$\begin{array}{r} 78 \\ - 23 \\ \hline \end{array}$$

$$96 \text{ l} - 31 \text{ l} = \underline{\quad}$$

$$\begin{array}{r} 96 \\ - 31 \\ \hline \end{array}$$

$$31 + 65 = \underline{\quad}$$

$$\begin{array}{r} 31 \\ + 65 \\ \hline \end{array}$$

Aula 23



fo ssa



massa

massa

peessoa



pêssego

pêssego

asseada

fa fe fi fo fu

ssa sse ssi sso ssu

ssa sse ssi sso ssu

Felipe cuida de sua saúde.
Ele é uma pessoa asseada.

Felipe cuida de sua

Ele é uma

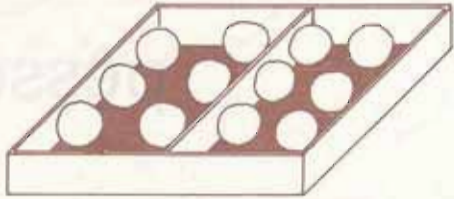

12

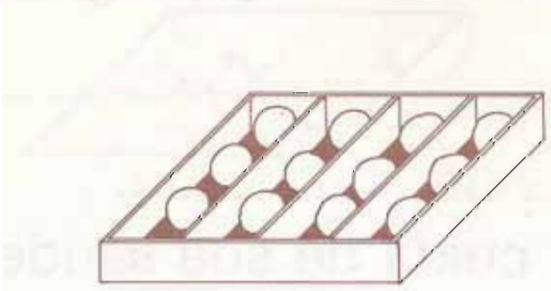
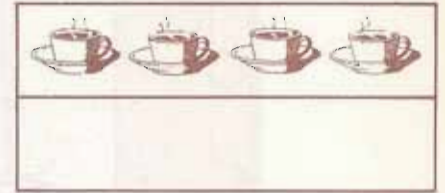
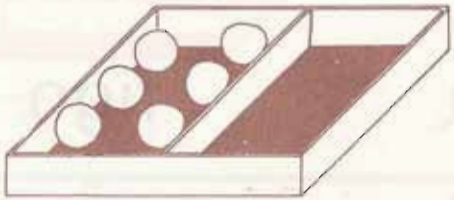

12

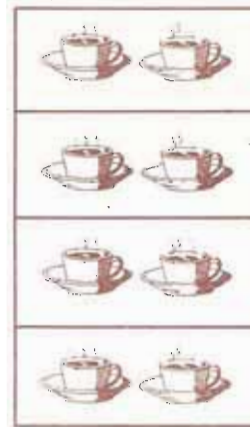
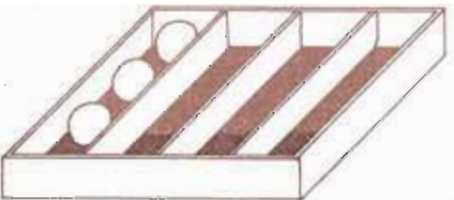



fossa

fo ssa

fa fo

ssa

a

fossa

fossa



pêssego

asseio

asseio

figo



figo

Lola cuida de sua saúde.
Ela é uma pessoa asseada.

Lola

Ela

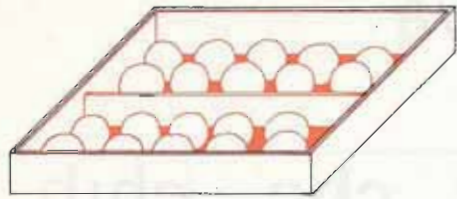

20

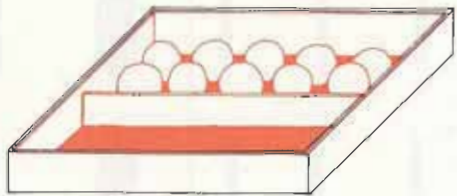

10

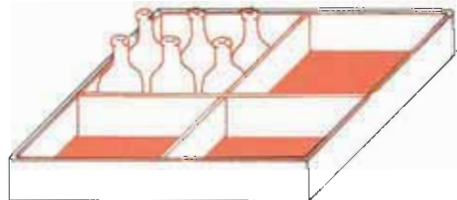
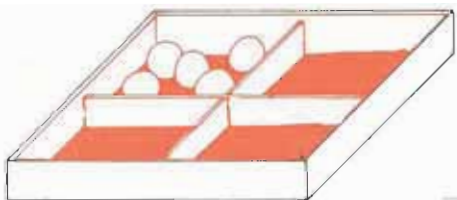
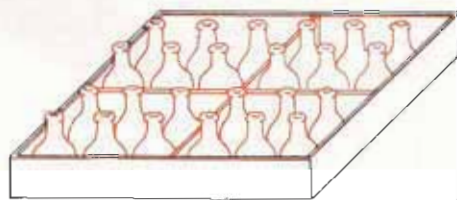
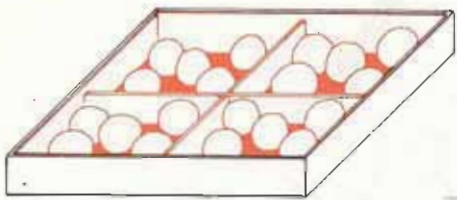
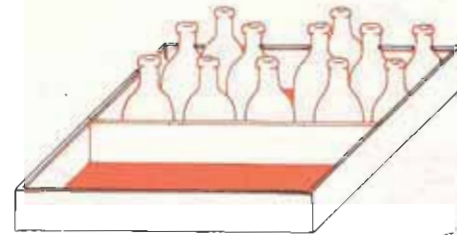
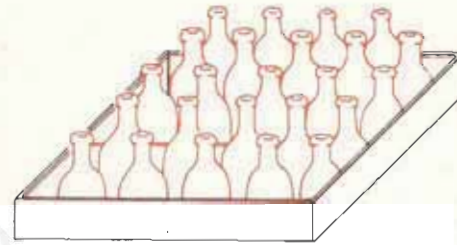

chu va

cha che chi cho chu



cha che chi cho chu

asseta

figo

chuva



chapéu



machado

chuva

chapéu

machado

Lola cuida da sua saúde.





Ela é uma pessoa assada.

chuva

chuchu



cachos

d	u
	
	

$$\begin{array}{r} 23 \\ + 23 \\ \hline \end{array}$$

$$\begin{array}{r} 23 \\ \times 2 \\ \hline \end{array}$$

$$\begin{array}{r} 32 \\ \times 3 \\ \hline \end{array}$$

$$\begin{array}{r} 21 \\ \times 4 \\ \hline \end{array}$$

cha che chi cho chu



chuva

chuva

chuva

cha

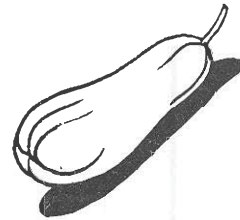

chuchu



chocolate

Beto é um ótimo colega. Ele me deu uma barra de chocolate.

Beto

choco



chicote



cachorro

chu va
chu va

chefe

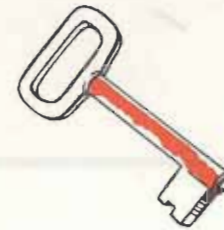

chave

va	va	
ve	ve	
vi	vi	
vo	vo	
vu	vu	

Chove muito. Davi chegou.
Ele veio de capa de chuva?

$$2 \times 41 \text{ l} = \underline{\quad} \text{ l}$$



$$\begin{array}{r} 41 \\ \times 2 \\ \hline \end{array}$$

$$2 \times 14 \text{ l} = \underline{\quad} \text{ l}$$

$$\begin{array}{r} 14 \\ \times 2 \\ \hline \end{array}$$

$$3 \times 22 \text{ l} = \underline{\quad} \text{ l}$$



$$\begin{array}{r} 22 \\ \times 3 \\ \hline \end{array}$$

$$3 \times 13 \text{ l} = \underline{\quad} \text{ l}$$

$$\begin{array}{r} 13 \\ \times 3 \\ \hline \end{array}$$

Aula 26



ra re ri ro ru

ça ço çu

ça ço çu

roça



poço



carroça

roça

roça

Paulo regou o roçado.
Ele leva o chuchu até a cidade.
A carroça ficou cheia.

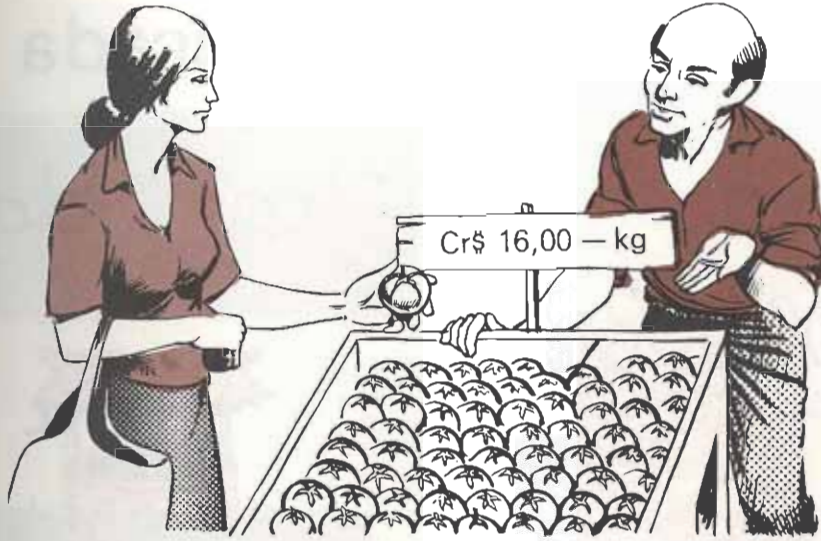

Cr \$ 16,00

Cr \$ 16,00



Cr \$



roça

roça

açude

caçada

a de

ca da



roçado

poço

ssa	assado	passa
chi	Chica	cochilo
ro	rolo	roda
ça	cabeça	caçada

A chuva é boa.
O açude fica cheio.



Cr \$500,00



Cr \$100,00



Aula 27



futebol



bolsa



filme

almoço

al

el

il

ol

ul

al

el

il

ol

ul

futebol

fu te bol



alto



Raul

Raul almoçou cedo.

Ele vai ao jogo de futebol

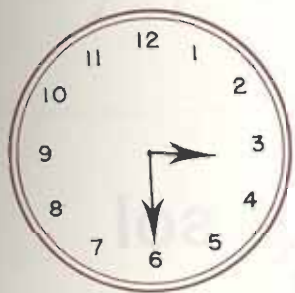
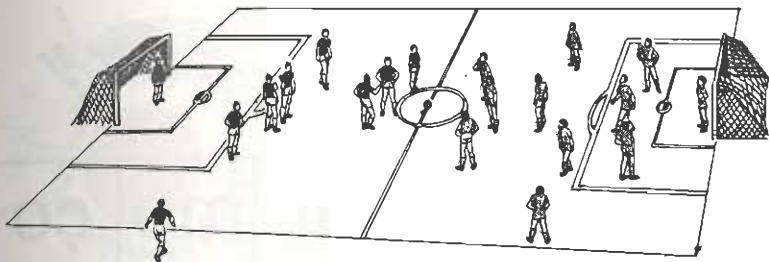

15 h 30 min

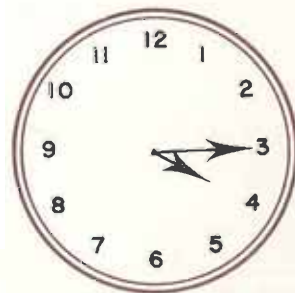
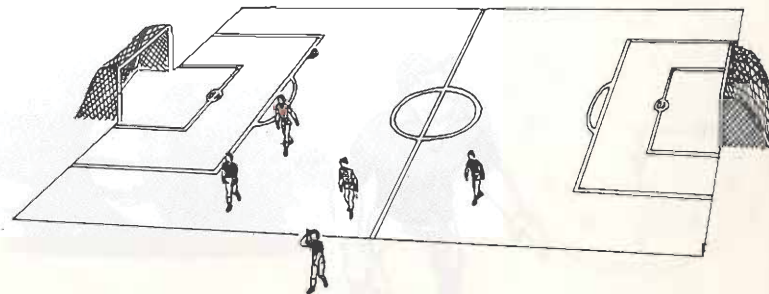

h min

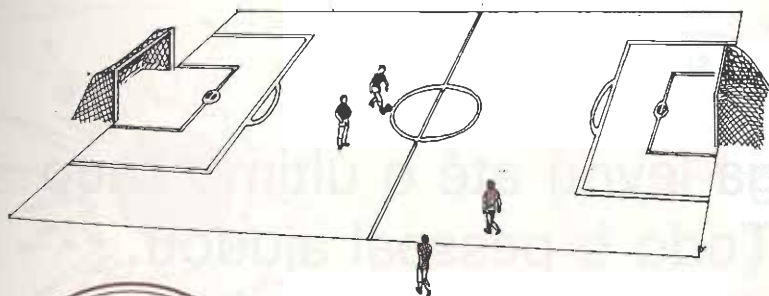

h min

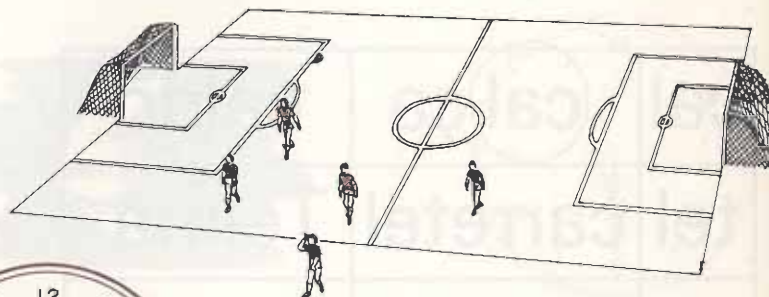

h min



futebol



bal de



al mo ço



papel

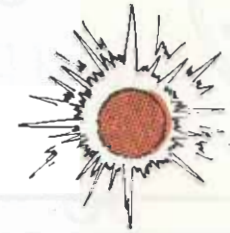

sol

cal	calça	caldo
tel	carretel	Telma
sol	soldado	solto
al	alma	alto
ul	Raul	último

Olga levou até o último saco de cal. Todo o pessoal ajudou.

Olga

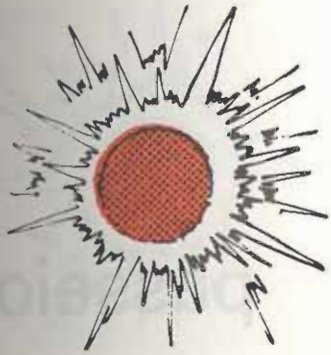

7 h 30 min

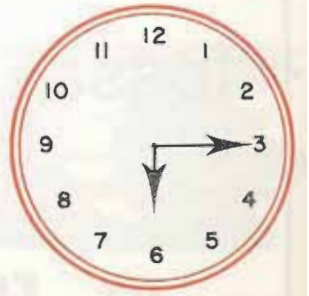

6 h 15 min

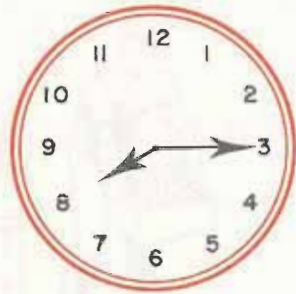
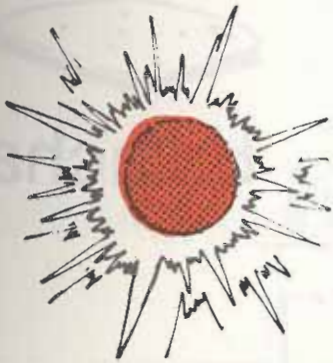

8 h 15 min

42 * 2 =

fossa  **chuva**

 **roça** 

 **futebol**

açude

a _ de

passaio

pa _ o



carretel



bolacha

fossa

chuva

roça

futebol

Ele coloca a peça na carroça.
A peça é feita de aço.

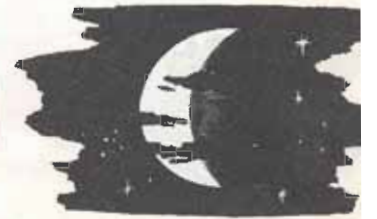
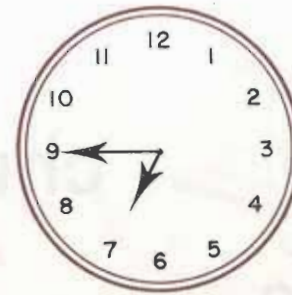
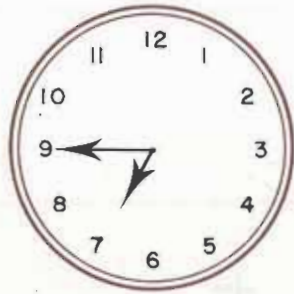
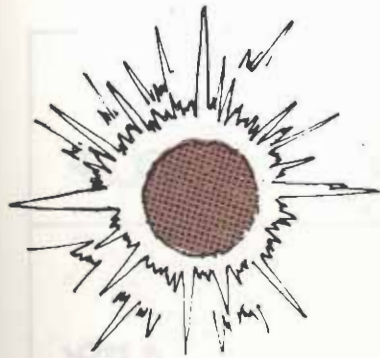

6h 45 min

h min + 12h h min

h min

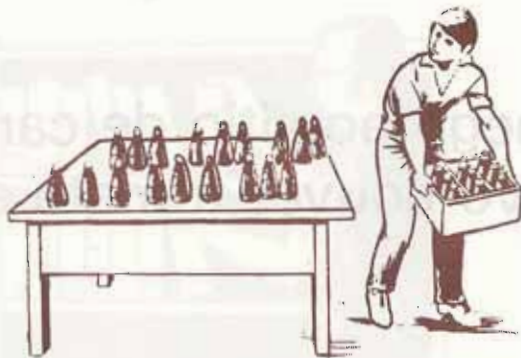

$$\begin{array}{r} 42 \\ \times 2 \\ \hline \end{array}$$

A metade de 18 é _____

$$42 \times 2 = \underline{\hspace{2cm}}$$

fossa



chuva



roça



futebol

ssa	ma <u>ss</u> a	a	do
al	to	vo	

chute

moça

	foca	faca
	poço	moço
	barro	barril
	chicote	chupeta

Chego ao sítio de carroça.
Levo couve, tomate e chuchu.

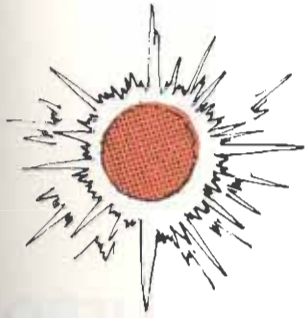

7h 15 min



h min

+ 12h

h min

h min



$$\begin{array}{r} 12 \\ \times 4 \\ \hline \end{array}$$

A metade de 14 é

$$12 \times 4 =$$



ar er ir or ur



círculo



urso

circo

circo



domador

doma

cortar

tar

O urso passa pelo arco.

O domador dá bala de mel ao urso.

cir co



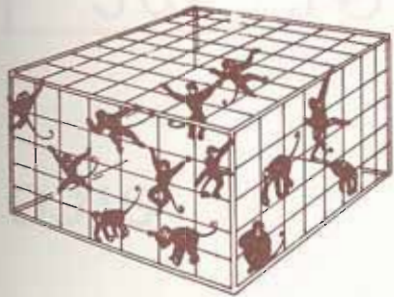
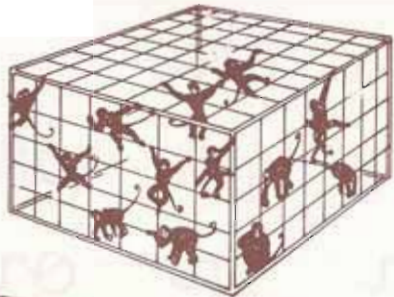
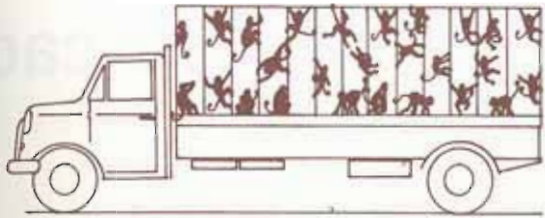

d	u

d	u

44 | 4

$$39 \div 3 = \underline{\quad}$$

39 | 3

$$26 \div 2 = \underline{\quad}$$



circo

circo

cir co



círculo



cercado

arte

ar er ir or ur
ar er ir or ur



arma



arco

cir	Moa cir	circular
mar	amargo	martelo
tir	partir	divertir
far	farmácia	farda

O urso sai do cercado.
O domador pega o chicote.
O animal vê a arma e volta.

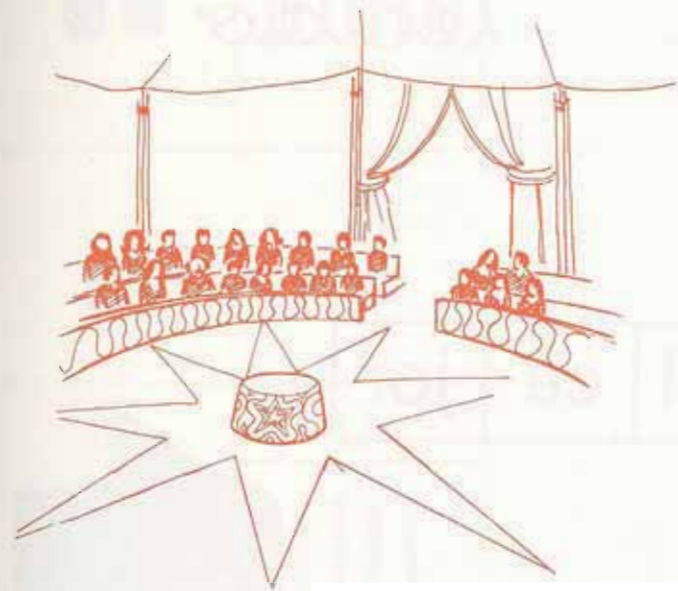

$$22 \div 2 =$$

d	u

d	u

$$\begin{array}{r}
 36 \quad \boxed{3} \\
 -3 \\
 \hline
 06 \\
 -6 \\
 \hline
 0
 \end{array}$$



cédula



tecido



cédula

tecido

circo

cir co

do nal ce jor

cidade

ce

ci



ce

ci

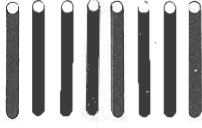

A aula acabou cedo.
Saí rápido da sala.
Eu vou ao circo da cidade.

d	u
	

d	u
	

$$\begin{array}{r}
 28 \quad | \quad 2 \\
 \hline
 -2 \\
 \hline
 08 \\
 \hline
 -8 \\
 \hline
 0
 \end{array}$$

$$\begin{array}{r}
 96 \quad | \quad 3 \\
 \hline
 \hline
 \hline
 0
 \end{array}$$

$$\begin{array}{r}
 48 \quad | \quad 4 \\
 \hline
 \hline
 \hline
 0
 \end{array}$$



circo

ce ci

ce ci

ar er ir or ur
ar er ir or ur



porta

_____ ta



corda

_____ da



alface

_____ ce



cebola

_____ da

O animal partiu a corda.
Cuidado! Ficou solto no cercado.

46

2

0

39

3

0

88

4

93

3

Aula 31



máquina

máquina

máquina

má qui na
ma me mi mo mu

que qui

que qui

quei ma da

que da

quilo

queijo

—Que pena! Queimou a máquina.
Vou colocar a peça boa.

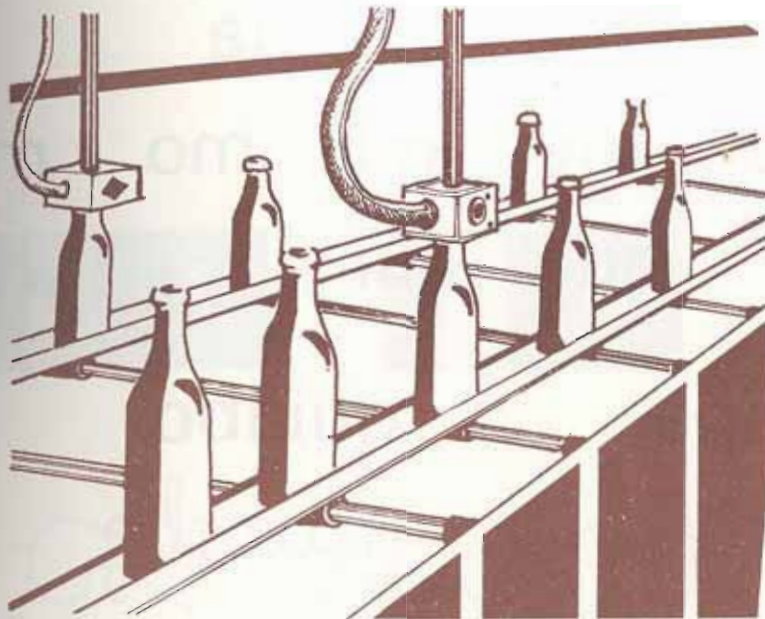

c	d	u
		
1	0	0

c	d	u
		

c	d	u
		

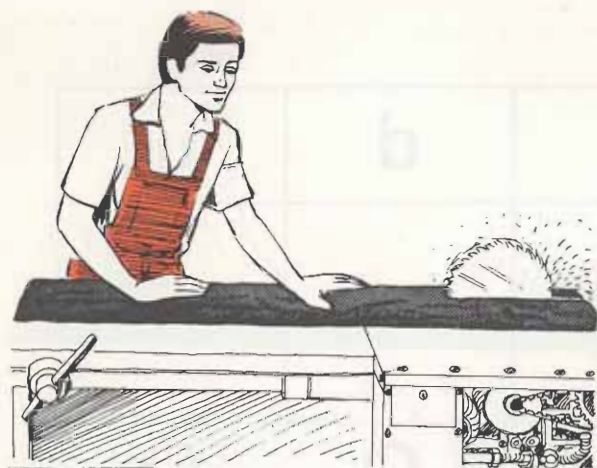

máquina

máquina

máquina

má qui na
ma me mi mo mu
que qui

equipe

equipe

quiabo

quiabo

quilo

moleque

—Que pena! Queimou a máquin
Vou colocar a peça boa.

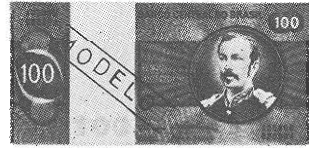

Gr \$ 200,00

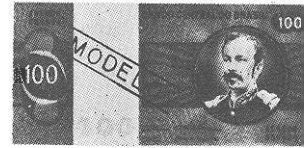
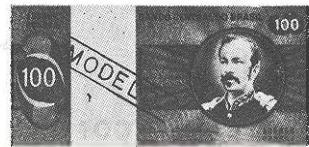

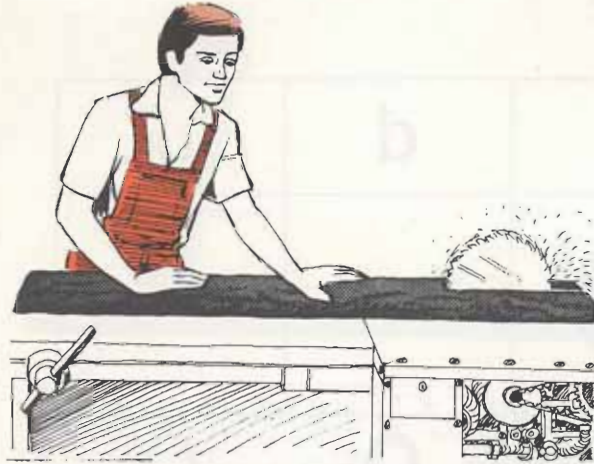

máquina

máquina

máquina

má qui na

ma me mi mo mu

que qui

equipe

quiabo

equipe

quiabo

quilo

moleque

—Que pena! Queimou a máquina.
Vou colocar a peça boa.



Gr \$ 200,00





máquina

máquina

máquina

má qui na
ma me mi mo mu
que qui

equipe

equipe

quilo

quiabo

quiabo

moleque

—Que pena! Queimou a máquina.
Vou colocar a peça boa.



Gr \$ 200,00

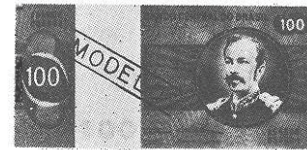



quartel

quartel

aquático

aquático

má qui na

qualidade

qua

qua

caqui



quilo de caqui



Levei todo caqui da barraca.
Ele é de boa qualidade.



$$\frac{1}{2} \text{ de } 12 = \underline{\hspace{2cm}}$$

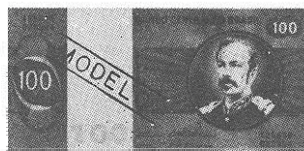

$$\frac{1}{2} \text{ de Cr\$ } 400,00 = \text{Cr\$ } \underline{\hspace{2cm}}$$



$$\underline{\hspace{2cm}} \text{ l}$$

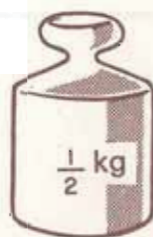

$$\frac{1}{2} \text{ kg} = \underline{\hspace{2cm}}$$

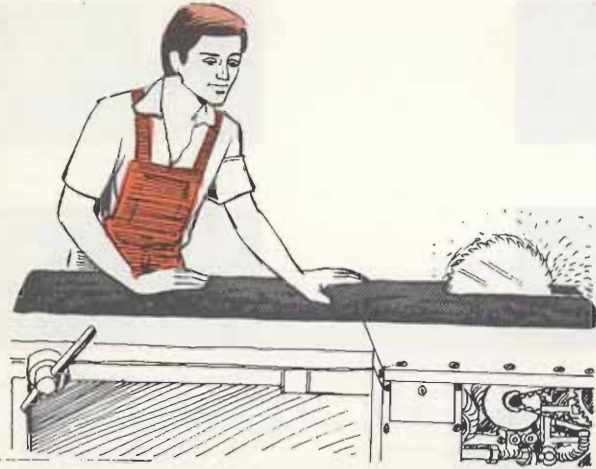

quarto

quarto

qualidade

qualidade

má qui na

má qui na

aquático

aquático

líquido

líquido

Veja que sorte! O móvel do quarto é de boa qualidade.

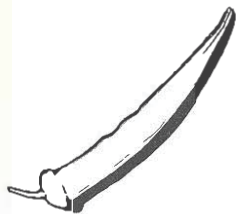

quiabo



$$\frac{1}{2} \text{ de } 24 =$$



$$\frac{1}{2} \text{ de } \text{Gr} \$ 200,00 = \text{Gr} \$$$



l



g

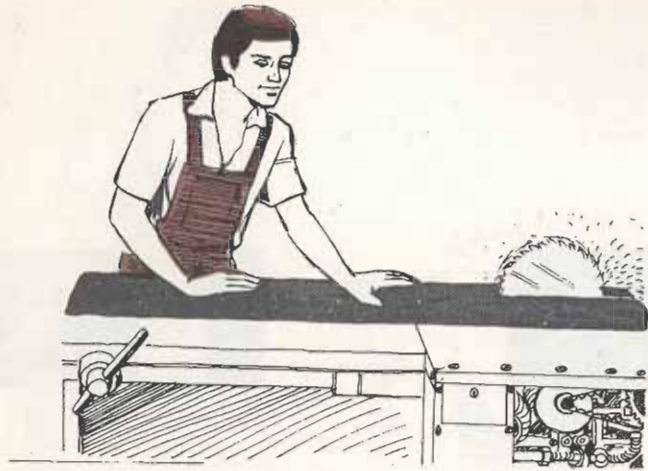

cena

cinema

máquina

má qui na



navio



mecânico

na ne ni no nu

na ne ni no nu

Renato carrega a máquina.
A máquina é de filmar.
Ele filmou uma cena no navio.

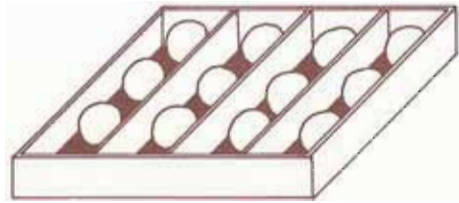

$$\frac{1}{4} \text{ de } 12 = \underline{\hspace{2cm}}$$



$$\frac{1}{4} \text{ de } \text{G}\$200,00 = \text{G}\$ \underline{\hspace{2cm}}$$



$$\frac{1}{4} \text{ kg} = \underline{\hspace{2cm}} \text{ g}$$



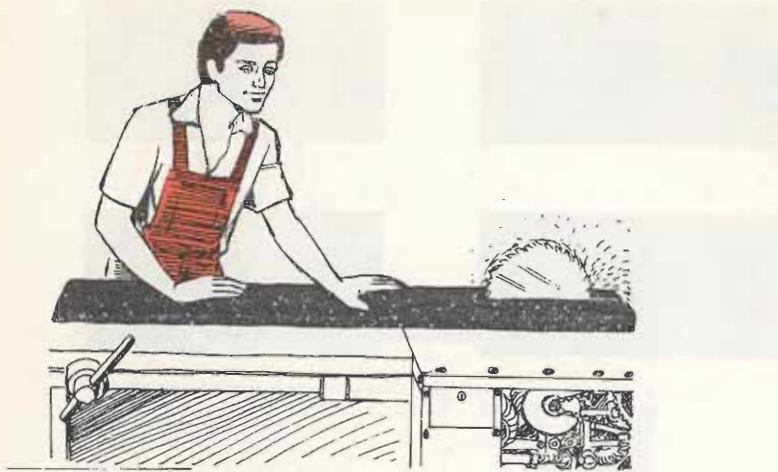

má qui na

má qui na

janela

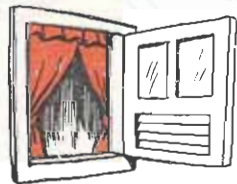

ca
ce
no
po

na
vo

cana

novo cinema

Veja que novidade!
Foi aberto o novo cinema na cidade.

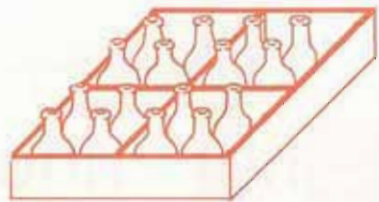

$$\frac{1}{4} \text{ de } 16 = \underline{\hspace{2cm}}$$



$$\frac{1}{4} \text{ de } \text{G}\$ 400,00 = \text{G}\$ \underline{\hspace{2cm}}$$



$$1 \text{ kg} = 250 \text{ g} + \underline{\hspace{2cm}} + \underline{\hspace{2cm}} + \underline{\hspace{2cm}}$$

Aula 34



di nhei ro
da de di do du
nha nhe nhi nho nhu

dinheiro

mi nha



ca mi nho

dinheiro

minha

caminho

dinheiro

Aquele é o caminho da cidade.
Veja se chega cedo lá.
Leve o dinheiro no bolso.

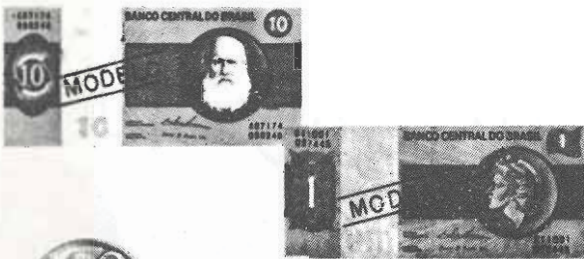

Cr \$ _____



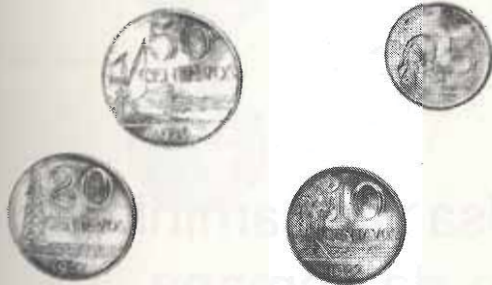





dinheiro

dinheiro

dinheiro

di nhei ro

di nhei ro

nha nhe nhi nho nhu

nha nhe nhi nho nhu

Perdi minha bolsa no caminho.
Tinha o dinheiro da semana.

Perdi

Tinha



Cr \$

Cr \$ 0,05

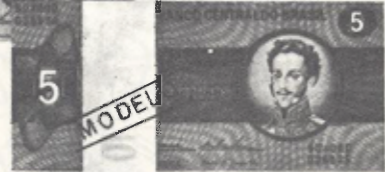

Cr \$ 11,00



fa rinha

fei ra

di nhei ro

fa_ nha

fei_

di nhei ro





fa ro fa

ba ra to

ra re ri ro ru

ra re ri ro ru

Maria mora na cidade.
Ela acha ótimo ir na feira.
Lá, tudo é muito barato.

 Cr\$ 6,00	 Cr\$ 1,00
 Cr\$ 6,50	 Cr\$ 2,50



$$\begin{array}{r}
 \text{Cr } \$ 6,00 \\
 + \text{Cr } \$ 2,50 \\
 \hline
 \text{Cr } \$ \underline{\quad\quad}
 \end{array}$$



$$\begin{array}{r}
 \text{Cr } \$ 6,50 \\
 + \text{Cr } \$ 1,00 \\
 \hline
 \text{Cr } \$ \underline{\quad\quad}
 \end{array}$$



$$\begin{array}{r}
 \text{Cr } \$ 27,00 \\
 - \text{Cr } \$ 11,00 \\
 \hline
 \text{Cr } \$ \underline{\quad\quad}
 \end{array}$$



di nhei ro

di nhei ro

ra re ri ro ru

ra re ri ro ru



pássaro



lenha



teia de aranha

caqui maduro







O menino mora na roça.

Ele viu uma teia de aranha.

○

Ele

a

	Cr\$ 10,00		Cr\$ 1,00
	Cr\$ 13,50		Cr\$ 2,50

a



$$\begin{array}{r}
 \text{Cr } \$ 10,00 \\
 + \text{Cr } \$ 2,50 \\
 \hline
 \text{Cr } \$ \underline{\hspace{2cm}}
 \end{array}$$



$$\begin{array}{r}
 \text{Cr } \$ 13,50 \\
 + \text{Cr } \$ 1,00 \\
 \hline
 \text{Cr } \$ \underline{\hspace{2cm}}
 \end{array}$$



$$\begin{array}{r}
 \text{Cr } \$ 66,00 \\
 - \text{Cr } \$ 15,00 \\
 \hline
 \text{Cr } \$ \underline{\hspace{2cm}}
 \end{array}$$



dinheiro

dinheiro



padeiro



lenhador

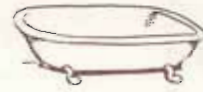

ba

ra



di

ro



bo

li

ár | vo | re

árvore

ma | dei | ra

madeira

A árvore dá a madeira.
O lenhador serra a árvore.
Como ela é útil!

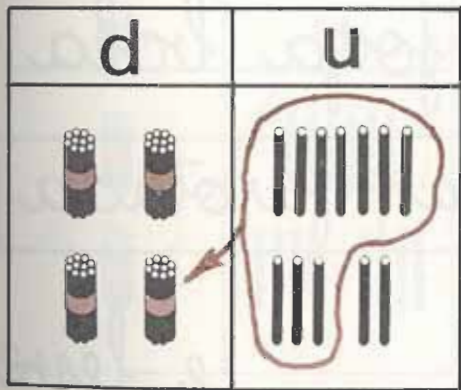
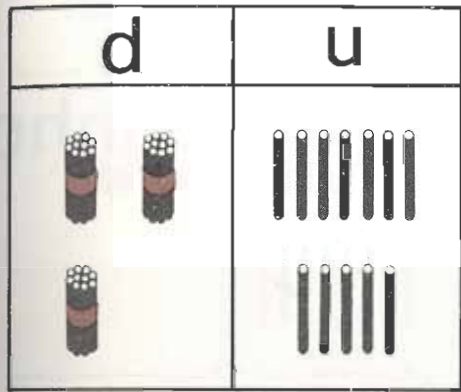

$$\begin{array}{r} 27 \\ + 15 \\ \hline \end{array}$$

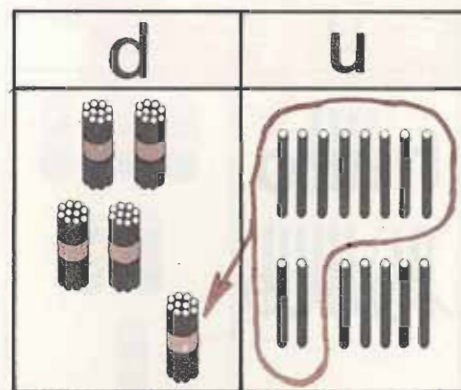
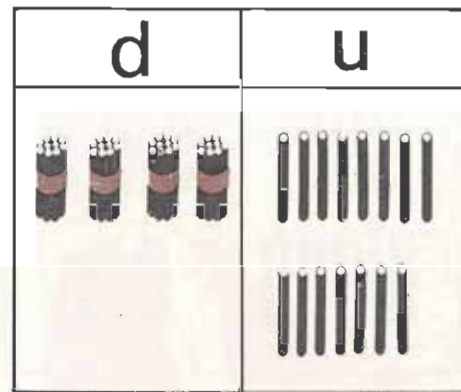
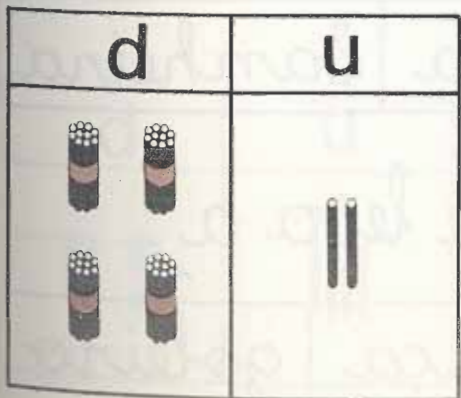

$$\begin{array}{r} 48 \\ + 7 \\ \hline \end{array}$$

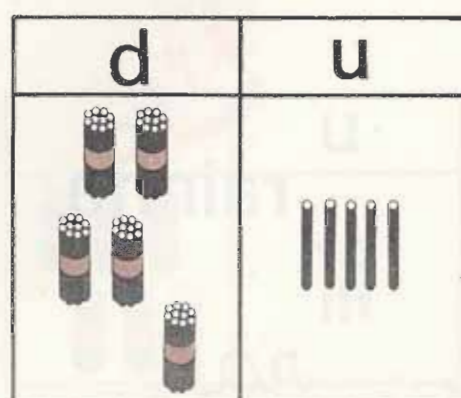



dinheiro
dinheiro



cadeira

ca_ ra



rainha

rai_



ninho



banho

A garotada joga bola

ninhada	garotada
---------	----------

A bola é colorida e lev

colorida	banheira
----------	----------

O time ganha e leva a ta

taça	goleiro
------	---------

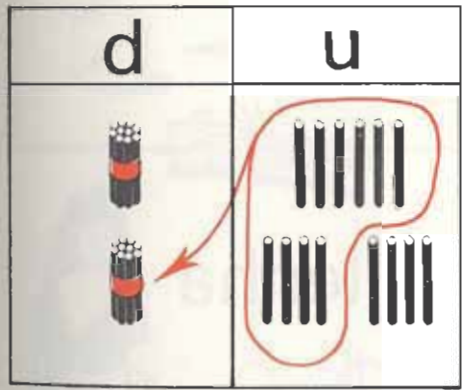
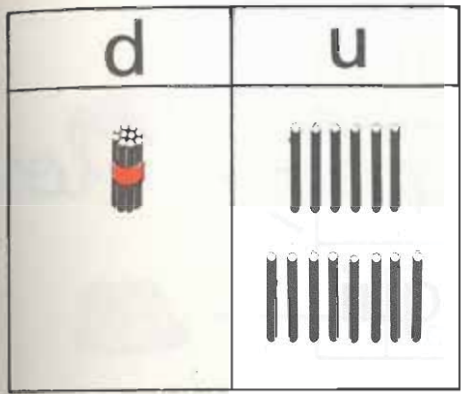

$$\begin{array}{r} 16 \\ + 8 \\ \hline \end{array}$$

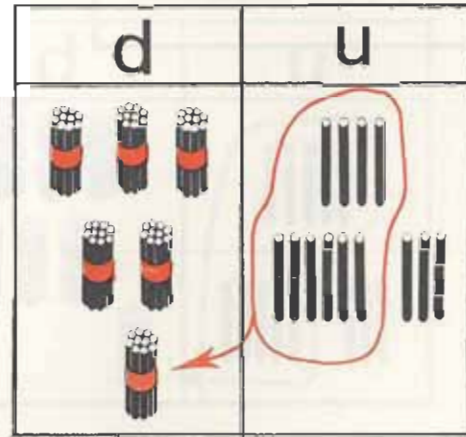
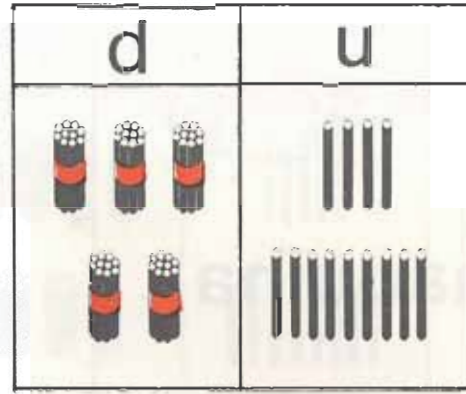
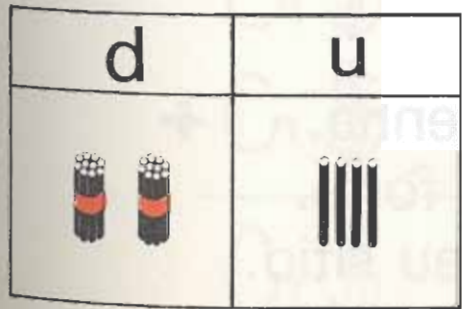

$$\begin{array}{r} 34 \\ + 29 \\ \hline \end{array}$$

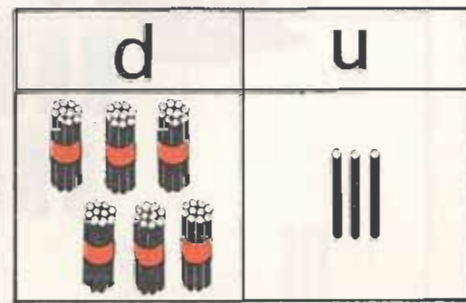

circo 

 **máquina**

dinheiro 

cor
por
for

da

que
qua
qui

lo





madeira



lenha





Achei madeira para lenha.
Amarrei numa corda forte.
Levei tudo para o meu sítio.







	←	batata Cr\$ 10,00 – kg
	←	tomate Cr\$ 12,00 – kg
	←	margarina Cr\$ 28,00 – kg







Cr\$ _____
 Cr\$ _____
 + Cr\$ _____

 Cr\$ _____

d	u
	
	

d	u
	
	
	

45
 + 38

d	u
	
	
	

- circo



máquina

dinheiro



arame



nadar

viajar de navio



via

Vou sair cedo.

Viajarei de navio. Que sonho!

ba



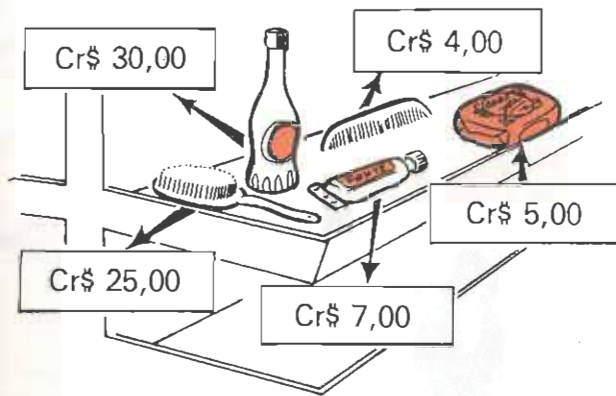

Cr\$ 30,00
 Cr\$ 4,00
 + Cr\$ 25,00

 Cr\$ _____

d	u

d	u

28
 + 36

d	u



tem
cam
lim

po

tempo

viagem

viagem

embarque

am em im om um
am em im om um

bagagem tombo

campo

tambor capim



empada

Também vou ao passeio no campo.
Levei empada e bolinho de carne
para o almoço.



$$\begin{array}{r} 25 \\ + 37 \\ \hline \end{array}$$



$$\begin{array}{r} 14 \\ + 9 \\ \hline \end{array}$$

$$\begin{array}{r} 57 \\ + 18 \\ \hline \end{array}$$



vi a gem
vi a gem

am em im om um

am em im om um

am em im om um

sam
bom
cam
tam

ba
po

samba

garagem de carro



Arrumei a bagagem cedo.
Ficou tudo em ordem.

Arrumei

Ficou

$$\begin{array}{r} 38 \\ + 5 \\ \hline \end{array}$$

$$\begin{array}{r} 25 \\ + 6 \\ \hline \end{array}$$

$$\begin{array}{r} 19 \\ + 16 \\ \hline \end{array}$$

$$\begin{array}{r} 47 \\ + 29 \\ \hline \end{array}$$

12	15	<u>18</u>			
----	----	-----------	--	--	--

20	<u>25</u>	30			45
----	-----------	----	--	--	----

42	<u>49</u>		63		
----	-----------	--	----	--	--

80	90	<u> </u>			130
----	----	------------	--	--	-----



gelo
ge gi
ge gi

viagem



gelado



relógio



viagem



lado



reló

viagem



Geraldo viu o relógio na parede.
Como chegou cedo!
Ele foi beber um suco gelado.

d	u
	



d	u
	



d	u
	
	

$$\begin{array}{r} 43 \\ - 16 \\ \hline \end{array}$$

d	u
	
	

$$\begin{array}{r} 24 \\ - 8 \\ \hline \end{array}$$

d	u
	

d	u
	



va

ve

vi

vo

vu

va

ge

gi

viagem

viagem

viagem



relógio de parede

Tirei a gelatina da geladeira.
Como tinha ficado gelada!

Tirei

Como

d	u

d	u

d	u

$$\begin{array}{r} 52 \\ - 35 \\ \hline \end{array}$$

d	u

$$\begin{array}{r} 37 \\ - 9 \\ \hline \end{array}$$

d	u

d	u



cru	<u>cru</u> a	recruta	cruel
bre	breve	brejo	lebre
gra	agrado	regra	grama
tri	atrato	trigo	tripa
dro	vidro	drogaria	cedro

professora

professora

professora

preço do vidro

Quero saber o preço do vidro.
Vou procurar no livro da loja.

Quero

Vou

$$\begin{array}{r} 95 \\ -18 \\ \hline \end{array}$$

$$\begin{array}{r} 23 \\ -8 \\ \hline \end{array}$$



$$\begin{array}{r} 82 \\ -36 \\ \hline \end{array}$$

$$\begin{array}{r} 61 \\ -6 \\ \hline \end{array}$$



professora

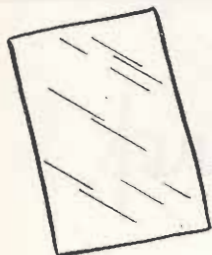

vidro

vi _____

vidraceiro

vi _____

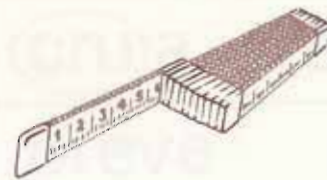

metro



comprar

compra do vidro

O vidraceiro vai colocar vidro na janela.
Ele mede a janela com o metro.
Agora ele já pode comprar o vidro.



3 m

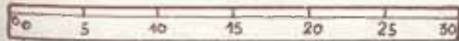
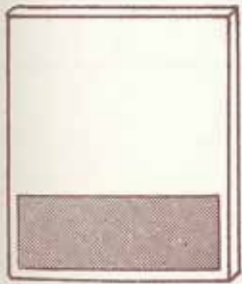

15 cm



2 km



pro fe sso ra



pedra

pedra



grade

gra vata
ma

pre ço
gador

preço do livro

A janela é de vidro.
Coloquei grade para proteger.

a
Coloquei



5 m



m

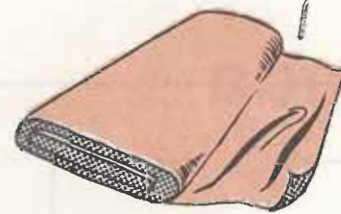

cm

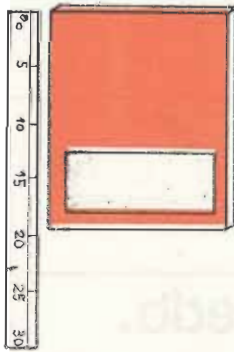

20 cm



km

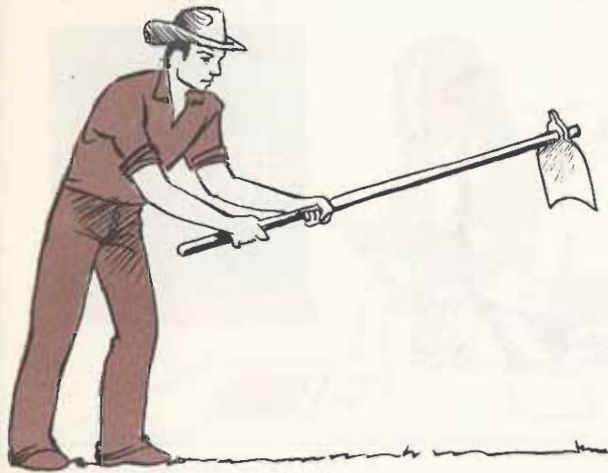

enxada

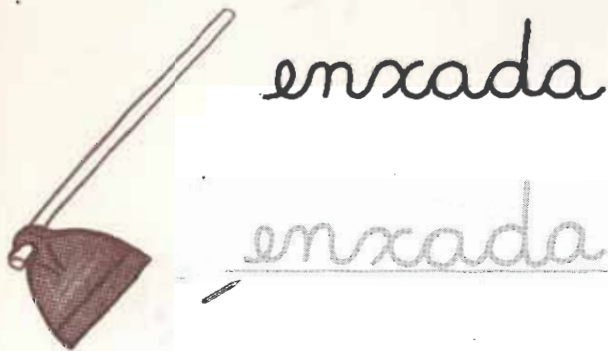

enxada

en xa da

an en in on un

an em in on un

on	tem
----	-----

can	tei	ro
-----	-----	----

se	men	te
----	-----	----

O grupo levantou cedo.
 Um pintou a cerca com tinta verde.
 Outro virou o canteiro com a enxada.
 A semente é jogada na terra tratada.

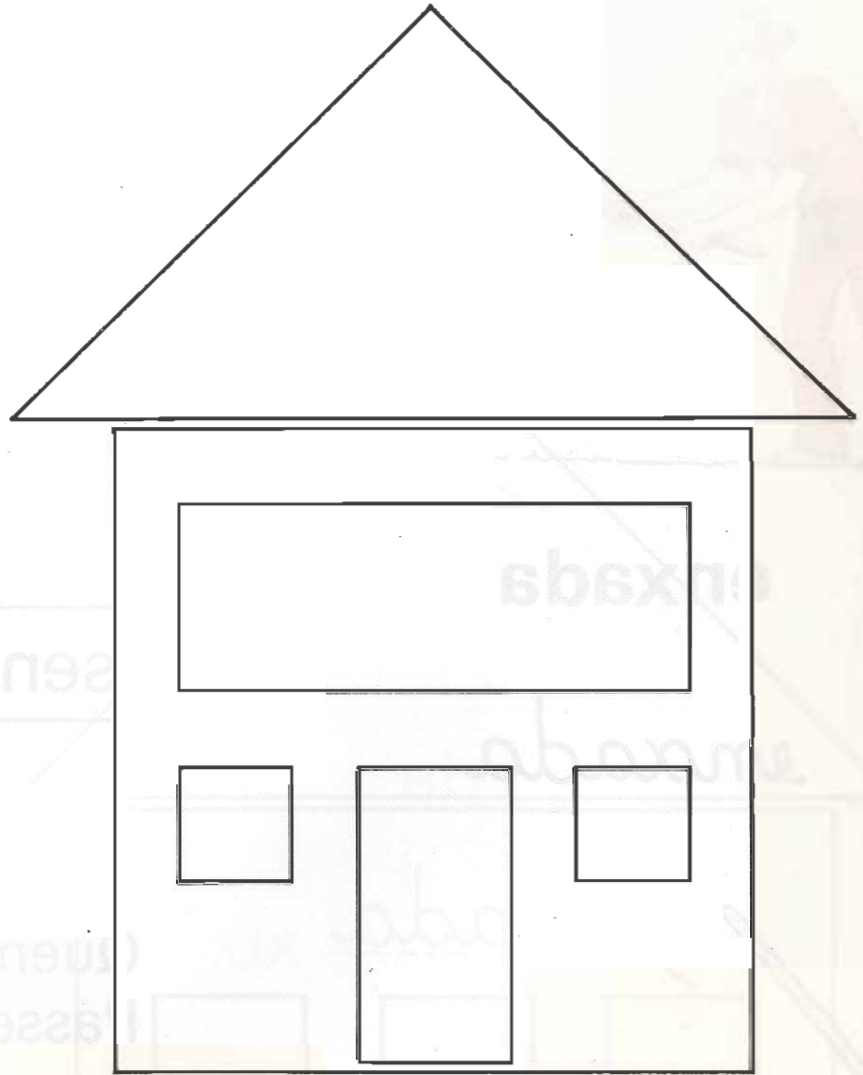
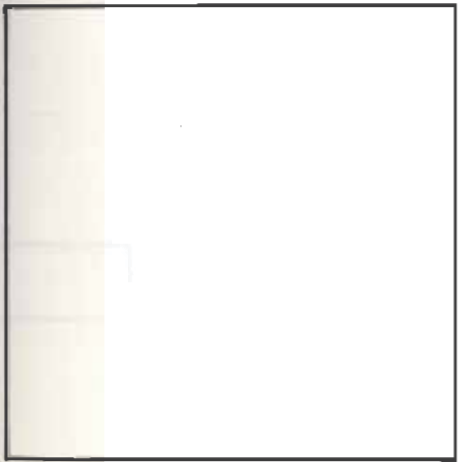
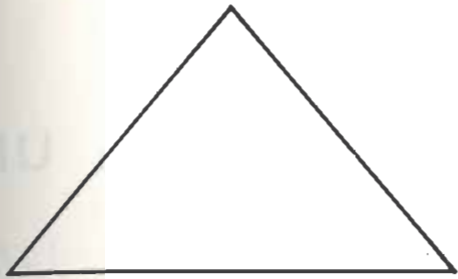

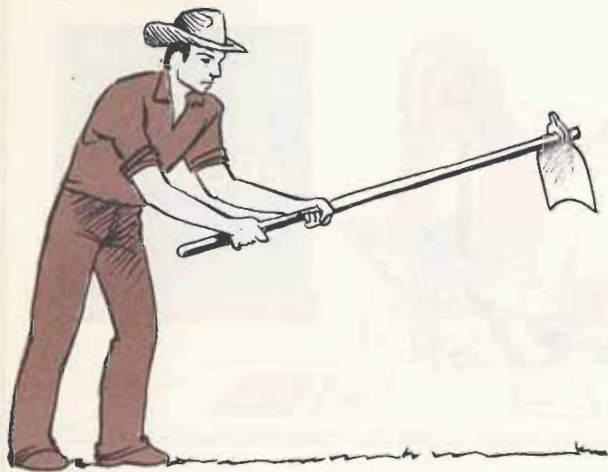

enxada

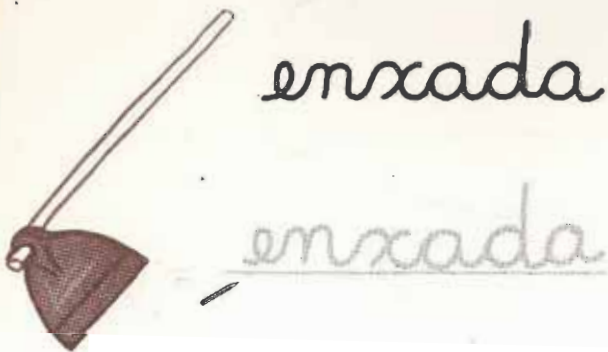

en xa da
an en in on un

an en in on un

on	tem
----	-----

can	tei	ro
-----	-----	----

se	men	te
----	-----	----

O grupo levantou cedo.
Um pintou a cerca com tinta verde.
Outro virou o canteiro com a enxada.
A semente é jogada na terra tratada.

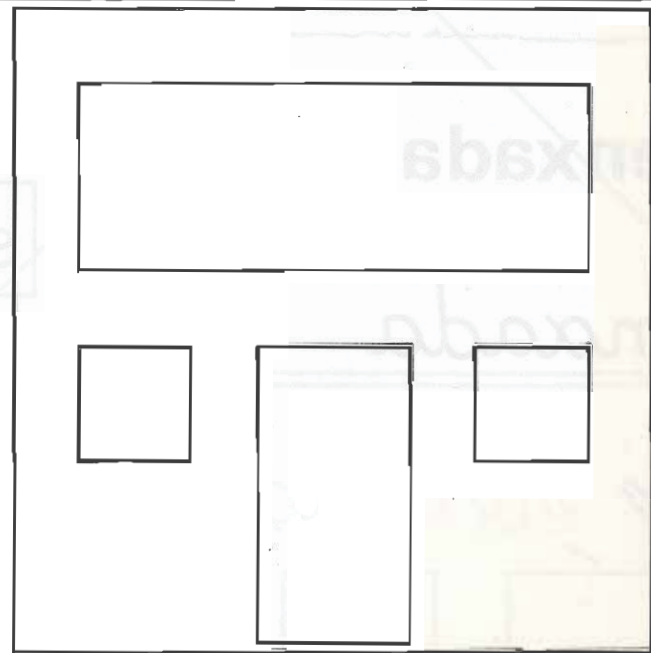
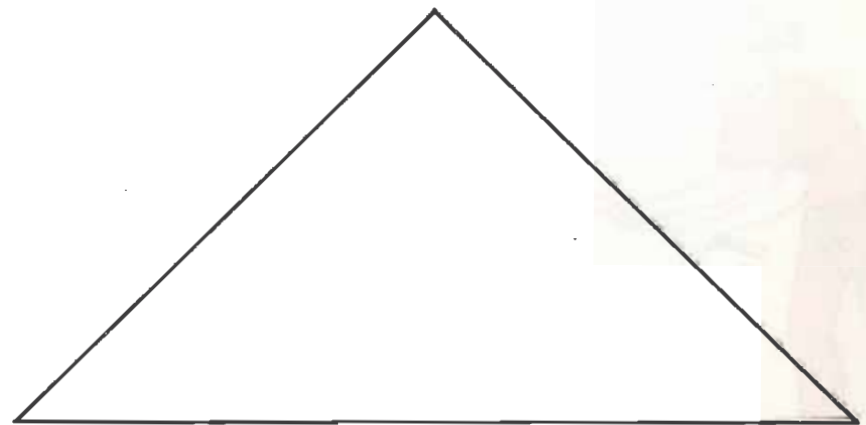
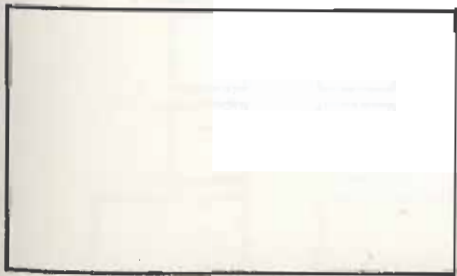
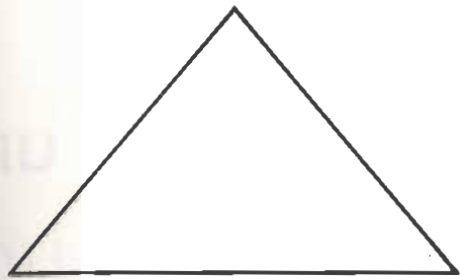



enxada

enxada



enxada

en xa da

an en in on un

an en in on un

tin ta

sen ta do

ban co

Quem ficou sentado no banco?
Passei a tinta ainda cedo.

Quem

Passei

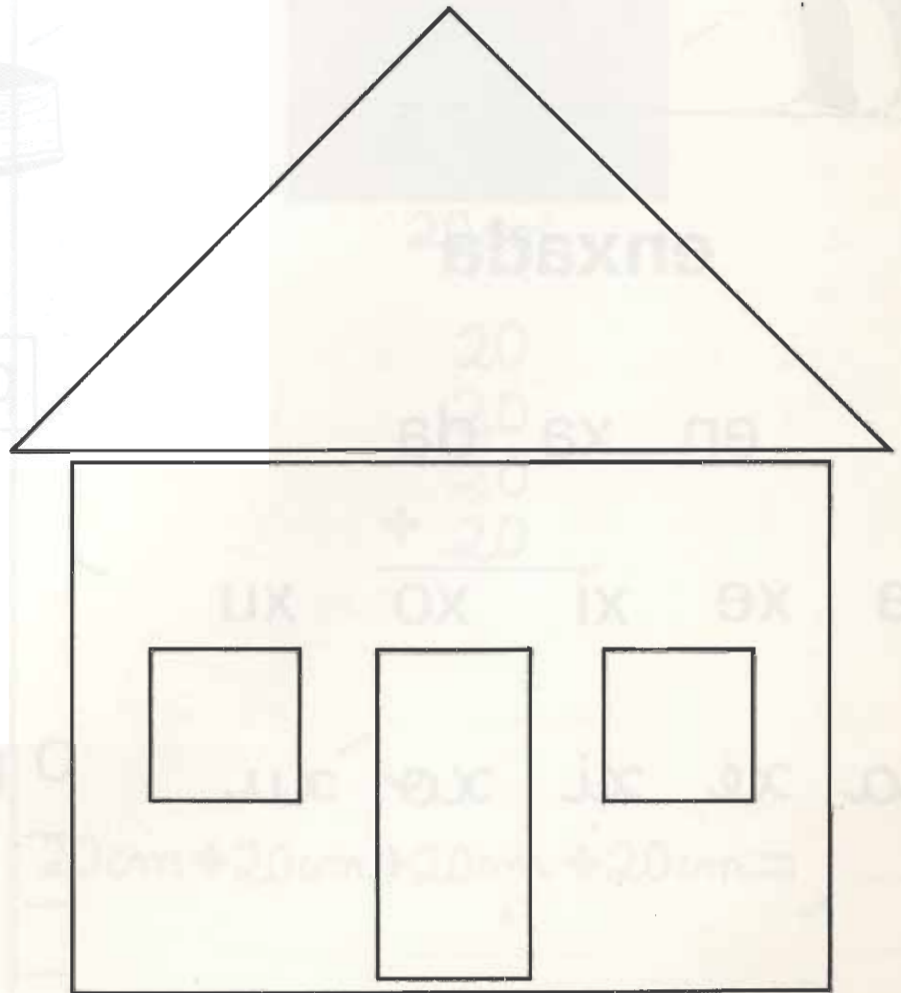
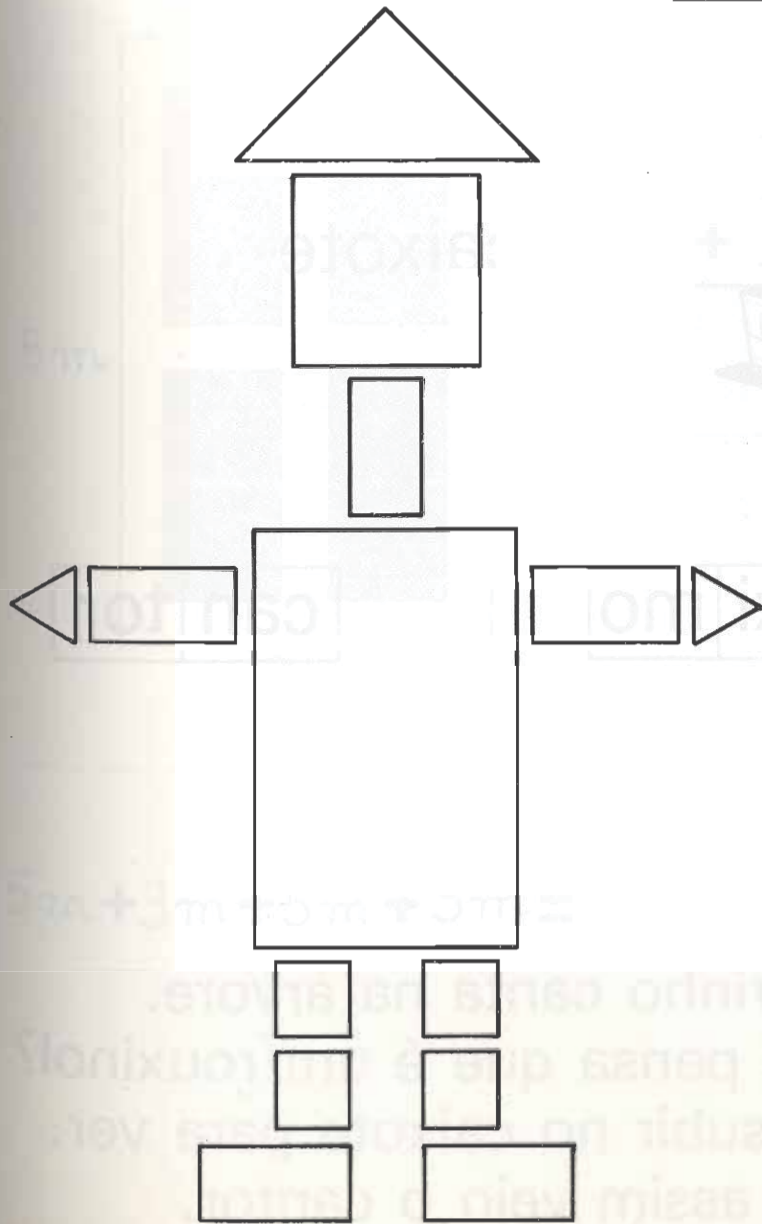
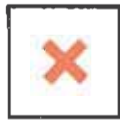

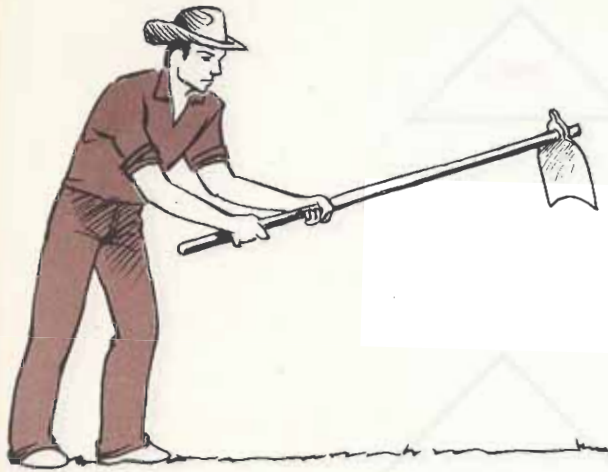

enxada

en xa da

xa xe xi xo xu

xa xe xi xo xu



rouxinol



caixote

pró xi mo

can tor

- O passarinho canta na árvore.
- Você pensa que é um rouxinol?
 - Vou subir no caixote para ver.
 - Nem assim vejo o cantor.

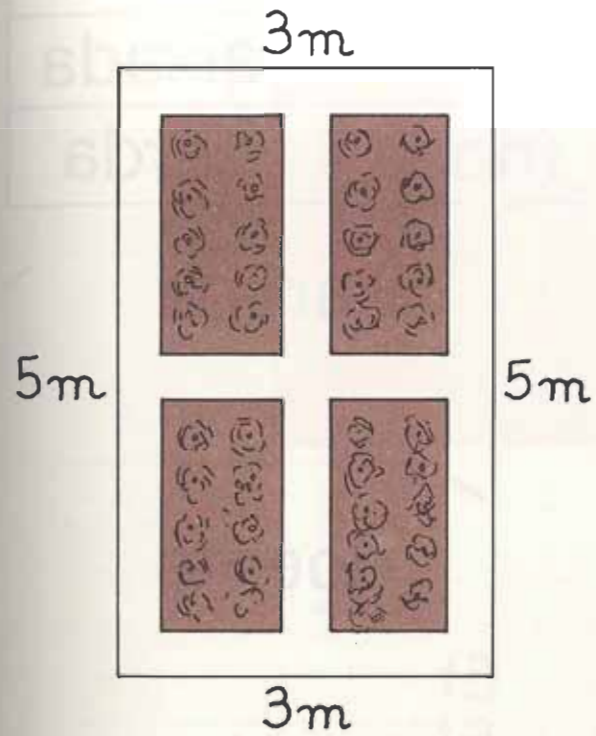

$$\begin{array}{r}
 3 \\
 + 3 \\
 \hline
 \end{array}$$

$$5m + 3m + 5m + 3m = \underline{\hspace{2cm}} m$$



$$\begin{array}{r}
 20 \\
 + 20 \\
 + 20 \\
 + 20 \\
 \hline
 \end{array}$$

$$20cm + 20cm + 20cm + 20cm = \underline{\hspace{2cm}}$$

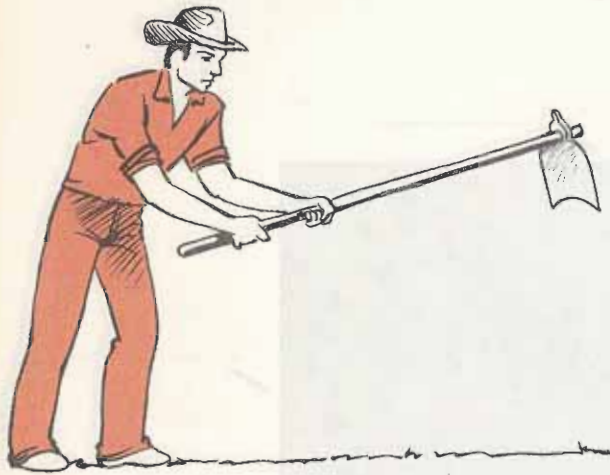

en xa da

xa xe xi xo xu

xa xe xi xo xu

en	entrada	enviar
xa	caixa	baixada
da	moda	corda



xarope



doente

O doente tosse muito.
O médico receitou um xarope.



13 m



10 cm

35 cm

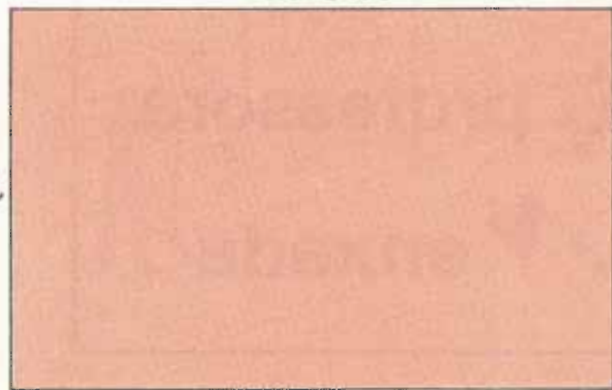

$$\begin{array}{r}
 13 \\
 13 \\
 13 \\
 + 13 \\
 \hline
 \end{array}$$

$$\begin{array}{r}
 35 \\
 10 \\
 35 \\
 + 10 \\
 \hline
 \end{array}$$

$$13\text{ m} + 13\text{ m} + 13\text{ m} + 13\text{ m} = \underline{\hspace{2cm}}\text{ m}$$

$$35\text{ cm} + 10\text{ cm} + 35\text{ cm} + 10\text{ cm} = \underline{\hspace{2cm}}$$

viagem



professora



enxada

fe

vi

xa

a

ra

gem

pro

da

ssso

en



de carro

bagagem

garagem



livro

fraco

grosso



de café

prato

xícara

O nosso país cultiva o café.
 Ele é torrado, moído e ensacado.
 A safra é embarcada no navio.
 A viagem é bem longa.



$$\begin{array}{r} 25 \\ + 48 \\ \hline \end{array}$$

$$25\text{cm} + 48\text{cm} = \underline{\hspace{2cm}}$$

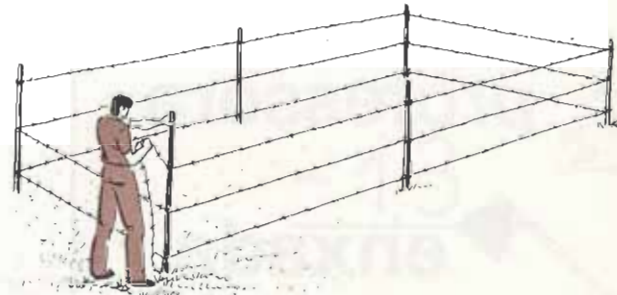

$$\begin{array}{r} 80 \\ - 54 \\ \hline \end{array}$$

$$80\text{m} - 54\text{m} = \underline{\hspace{2cm}}$$

viagem 

 **professora**

 **enxada**

bagagem



bagagem

enxame



pre go



tra tor

pom

bom

sam

ba

O lavrador tem que semear.
Ele passa o trator no terreno.
O campo fica preparado.

$$\begin{array}{r} 45 \\ +37 \\ \hline \end{array}$$

$$\begin{array}{r} 52 \\ -13 \\ \hline \end{array}$$



$$\begin{array}{r} 12 \\ +79 \\ \hline \end{array}$$

$$\begin{array}{r} 35 \\ -17 \\ \hline \end{array}$$

viagem



professora



enxada

bagagem



baga

enxame



pre go



tra tor

pom

bom

sam

ba

O lavrador tem que semear.
Ele passa o trator no terreno.
O campo fica preparado.

$$\begin{array}{r} 45 \\ + 37 \\ \hline \end{array}$$

$$\begin{array}{r} 52 \\ - 13 \\ \hline \end{array}$$



$$\begin{array}{r} 12 \\ + 79 \\ \hline \end{array}$$

$$\begin{array}{r} 35 \\ - 17 \\ \hline \end{array}$$

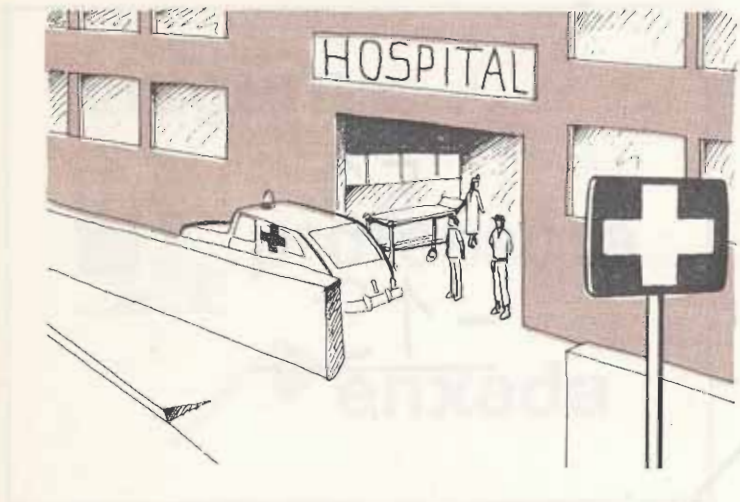

hospital

homem



higiene

horário

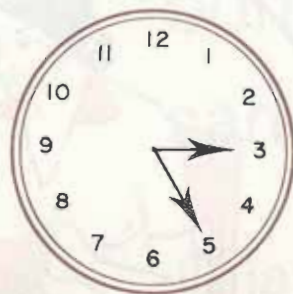

has hes his hos hus

ho
 / ra
 / je

hos	hóspede	hóstia
his	história	histórico
has	hastear	haste

O homem ficou doente.
 Ele irá ao posto de saúde.
 Vai consultar um médico.
 O horário da consulta é à uma hora.

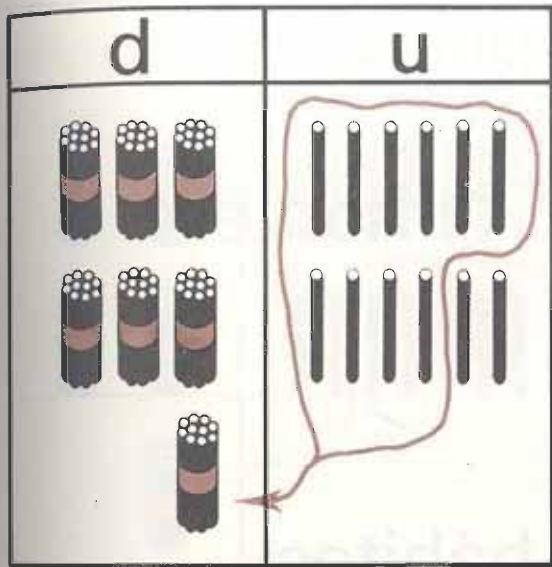

$$\begin{array}{r} 36 \\ \times 2 \\ \hline \end{array}$$

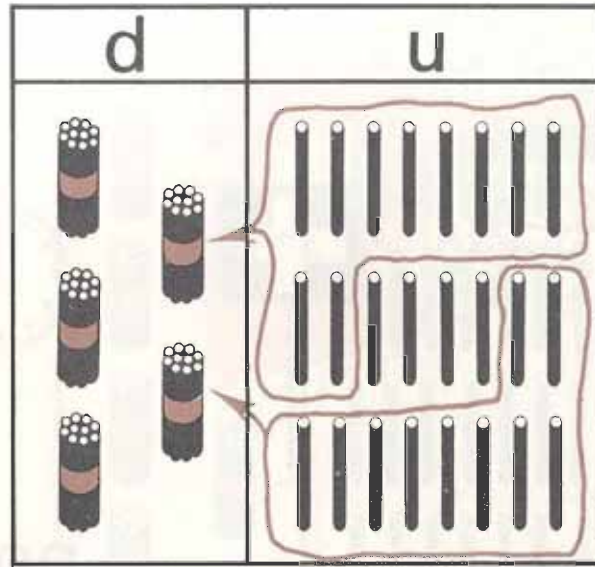

$$\begin{array}{r} 18 \\ \times 3 \\ \hline \end{array}$$

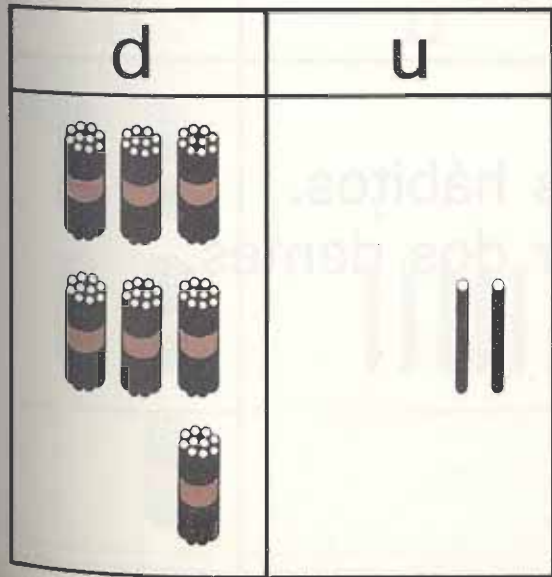

$$\begin{array}{r} \\ \hline \end{array}$$

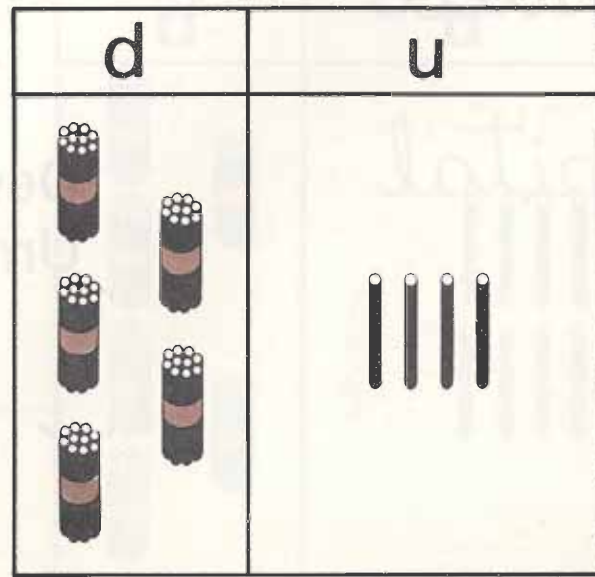

$$\begin{array}{r} \\ \hline \end{array}$$



hospital

hospital

hospital

hos pi tal



hora

posto



homem

hábitos

Devemos ter bons hábitos.
Um deles é cuidar dos dentes.

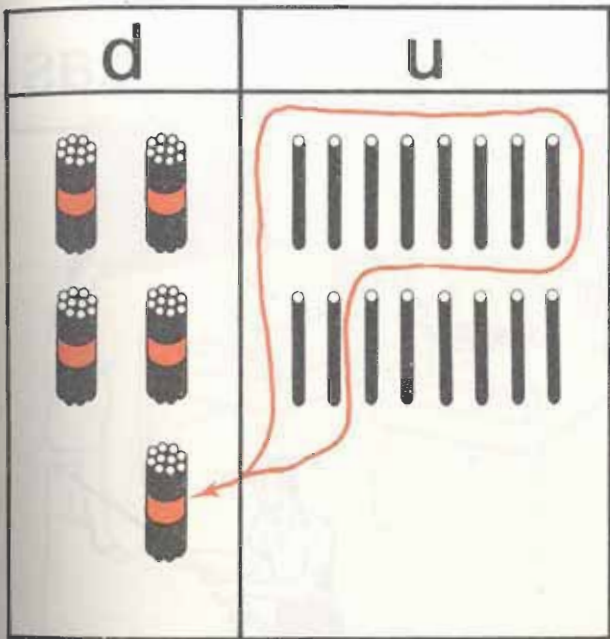

$$\begin{array}{r} 28 \\ \times 2 \\ \hline \end{array}$$

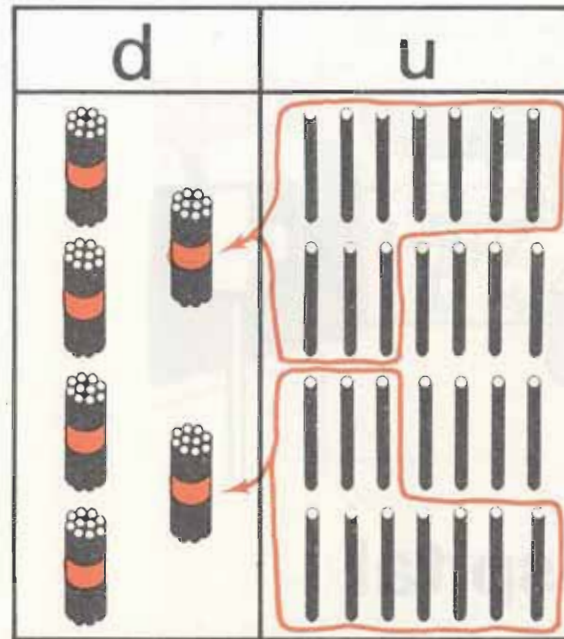

$$\begin{array}{r} 17 \\ \times 4 \\ \hline \end{array}$$

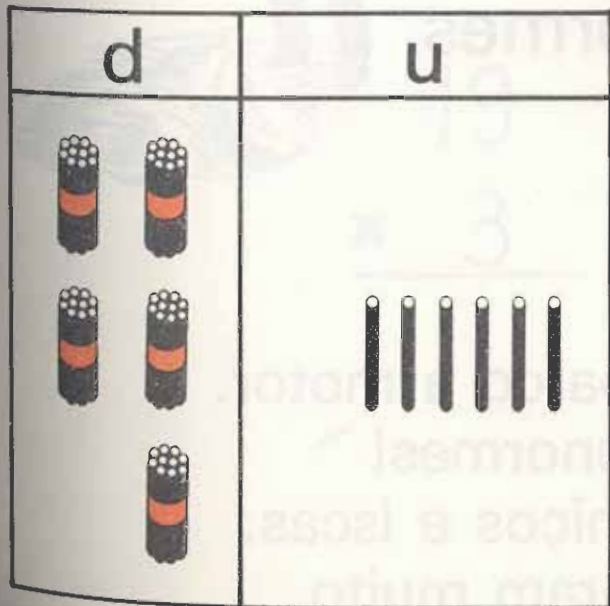

$$\begin{array}{r} \\ 3 \\ \hline \end{array}$$

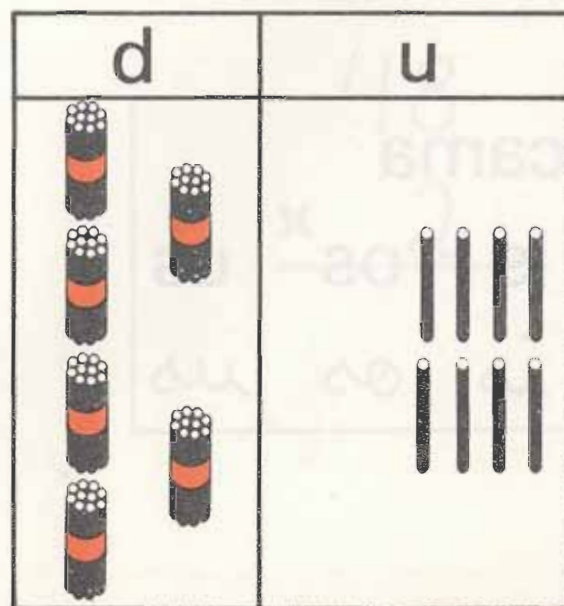

$$\begin{array}{r} \\ 2 \\ \hline \end{array}$$



hospital

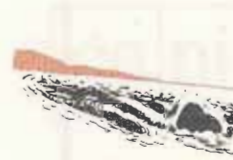

ondas

ondas



cestas

cestas



escamas



ostras

as	as ma	ruas
es	escama	espada
is	isca	país
os	ostra	Oscar

Fomos passear de barco.
Levamos caniços e iscas.
Que boa pescaria!

$$\begin{array}{r} 46 \\ \times 2 \\ \hline \end{array}$$

$$\begin{array}{r} 27 \\ \times 3 \\ \hline \end{array}$$



$$\begin{array}{r} 17 \\ \times 5 \\ \hline \end{array}$$

$$\begin{array}{r} 19 \\ \times 4 \\ \hline \end{array}$$



lim pe za

za ze zi zo zu

za ze zi zo zu

limpeza

be	le	za
----	----	----

va	zi	a
----	----	---

limpeza

beleza

vazia

limpeza

As lâmpadas apagaram.
O céu estava uma beleza. A luz da
lanterna iluminava a rua vazia.

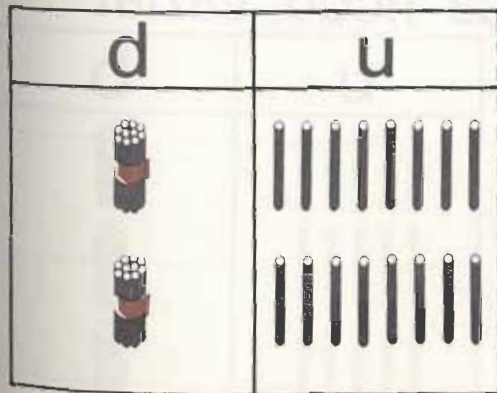
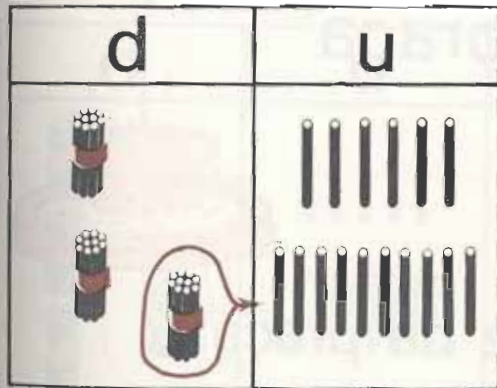
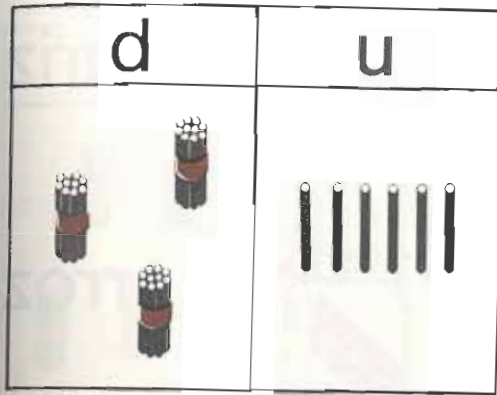

$$\begin{array}{r}
 36 \overline{) 2} \\
 \underline{-2} \\
 6 \\
 \underline{-6} \\
 0
 \end{array}$$

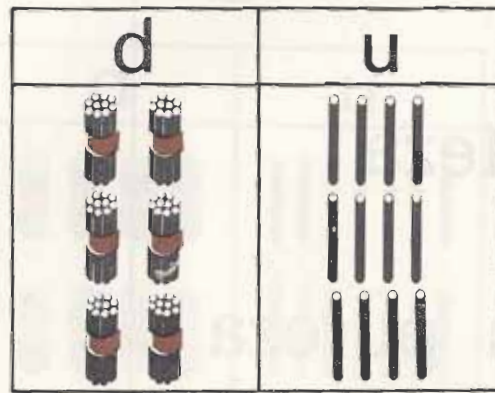
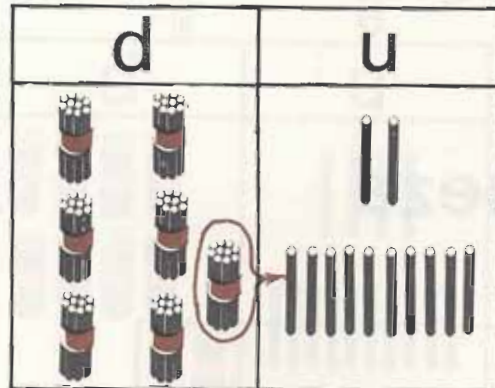
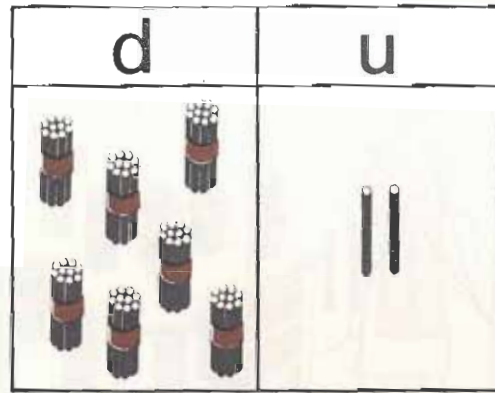

$$\begin{array}{r}
 72 \overline{) 3} \\
 \underline{-6} \\
 12 \\
 \underline{-12} \\
 0
 \end{array}$$



limpeza

beleza limpe(za)

certeza

magreza pureza



luz



azeite



nariz



arroz

o chafariz da praça



É lindo o chafariz da praça.
Hoje as luzes se apagaram.
Que pena, a praça ficou vazia!

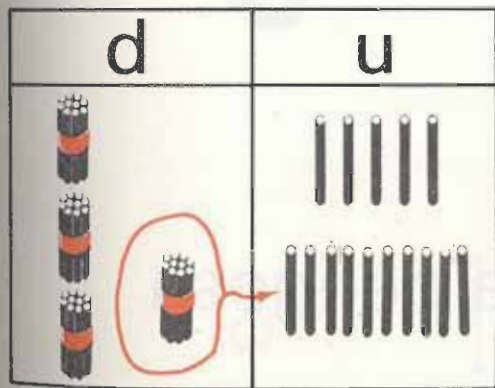
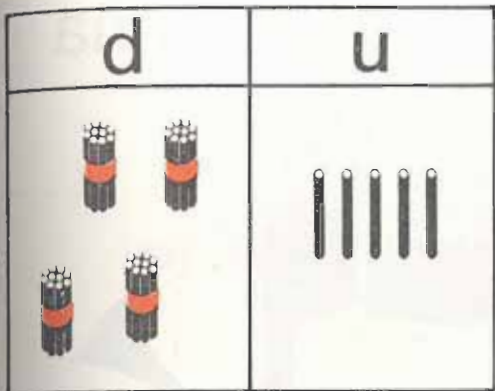

$$\begin{array}{r} 45 \overline{) 3} \\ -3 \\ \hline \end{array}$$

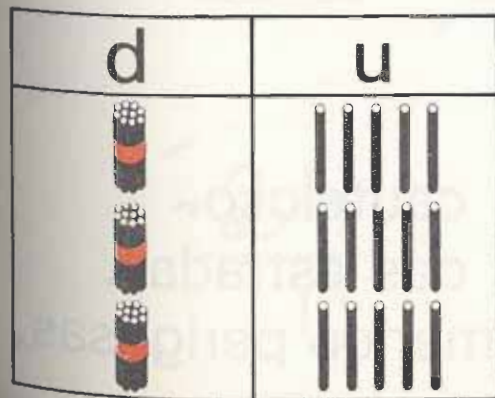

$$\begin{array}{r} \overline{) 15} \\ -15 \\ \hline 0 \end{array}$$

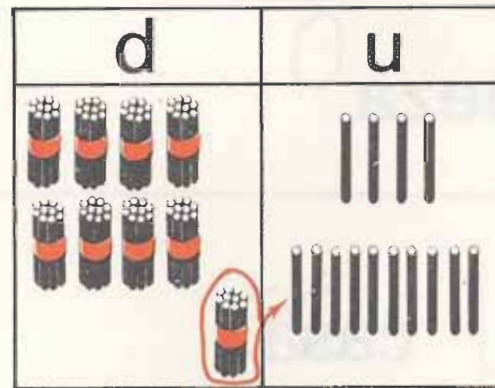
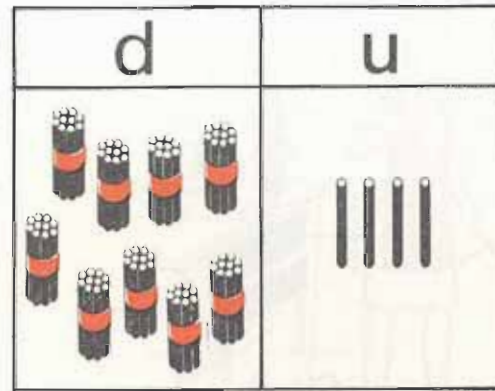

$$\begin{array}{r} 94 \overline{) 2} \\ -8 \\ \hline \end{array}$$

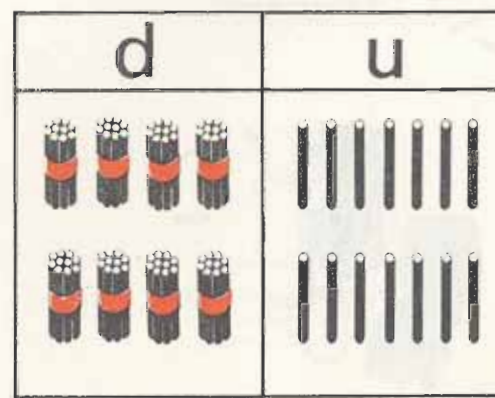

$$\begin{array}{r} \overline{) 14} \\ -14 \\ \hline 0 \end{array}$$



limpeza



casa

casa

zelo

zelo



aviso

gasolina

buzina



estrada perigosa

Cuidado! Seja cauteloso.
Leia os avisos das estradas.
Assim, ficam menos perigosas.



$$\begin{array}{r}
 30 \quad | \quad 2 \\
 -2 \\
 \hline
 \\
 \hline
 10 \\
 -10 \\
 \hline
 0
 \end{array}$$

$$\begin{array}{r}
 84 \quad | \quad 3 \\
 -6 \\
 \hline
 \\
 \hline
 24 \\
 -24 \\
 \hline
 0
 \end{array}$$

$$\begin{array}{r}
 52 \quad | \quad 4 \\
 -4 \\
 \hline
 \\
 \hline
 12 \\
 -12 \\
 \hline
 0
 \end{array}$$



limpeza



casa

casaco



me

sa

ro

va

so

li

luz acesa



O vaso azul está com rosas.
Vou receber visitas em casa.

$$\begin{array}{r} 75 \quad | \quad 3 \\ -6 \\ \hline \end{array}$$

$$\begin{array}{r} \overline{-15} \\ 0 \end{array}$$

$$\begin{array}{r} 32 \quad | \quad 2 \\ -2 \\ \hline \end{array}$$

$$\begin{array}{r} \overline{-12} \\ 0 \end{array}$$

$$\begin{array}{r} 65 \quad | \quad 5 \\ -5 \\ \hline \end{array}$$

$$\begin{array}{r} \overline{-15} \\ 0 \end{array}$$

$$\begin{array}{r} 60 \quad | \quad 4 \\ -4 \\ \hline \end{array}$$

$$\begin{array}{r} \overline{-20} \\ 0 \end{array}$$



foguete

foguete

foguete

fo gue te
gue gui
que qui

gue	caranguejo	mangue
gui	seguida	águia

som da guitarra

Soltamos foguetes na festa.
Em seguida, pulamos a fogueira.
Também dançamos ao som da guitarra.
Nunca vi tanta alegria!

$$\begin{array}{r} 35 \\ +19 \\ \hline \end{array}$$

$$\begin{array}{r} 40 \\ -17 \\ \hline \end{array}$$

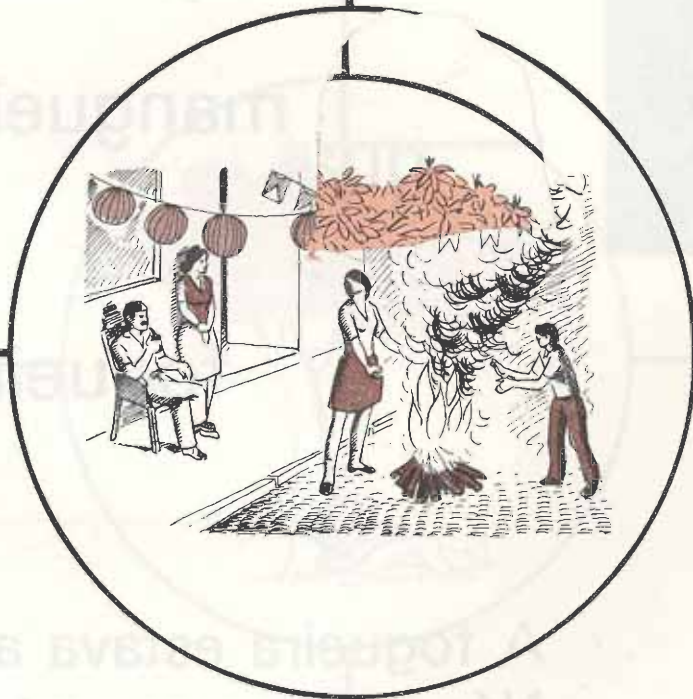

$$\begin{array}{r} 23 \\ \times 4 \\ \hline \end{array}$$

$$74 \overline{) 2}$$

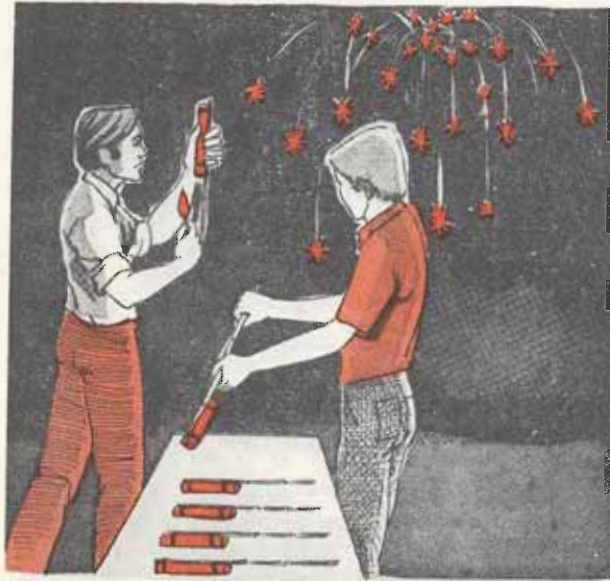

foguete

foguete

foguete

fo gue te
gue gui

mangueira



águia

fogueira acesa

A fogueira estava acesa.
Nós sentamos perto da mangueira.

$$\begin{array}{r} 53 \\ +28 \\ \hline \end{array}$$

$$\begin{array}{r} 60 \\ -24 \\ \hline \end{array}$$



$$\begin{array}{r} 26 \\ \times 3 \\ \hline \end{array}$$

$$92 \overline{) 2}$$



foguete

fo gue te

água

gua

gua

á



guaraná

guardado

guardanapo

guardanapo de papel



Hoje é dia de festa.

Comprei várias garrafas de guaraná.
Elas foram guardadas na geladeira.

$\frac{1}{2} m$

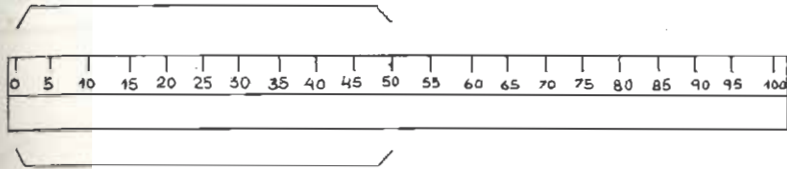

cm

$\frac{1}{4} m$

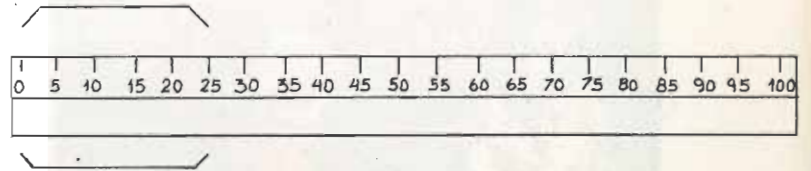

cm

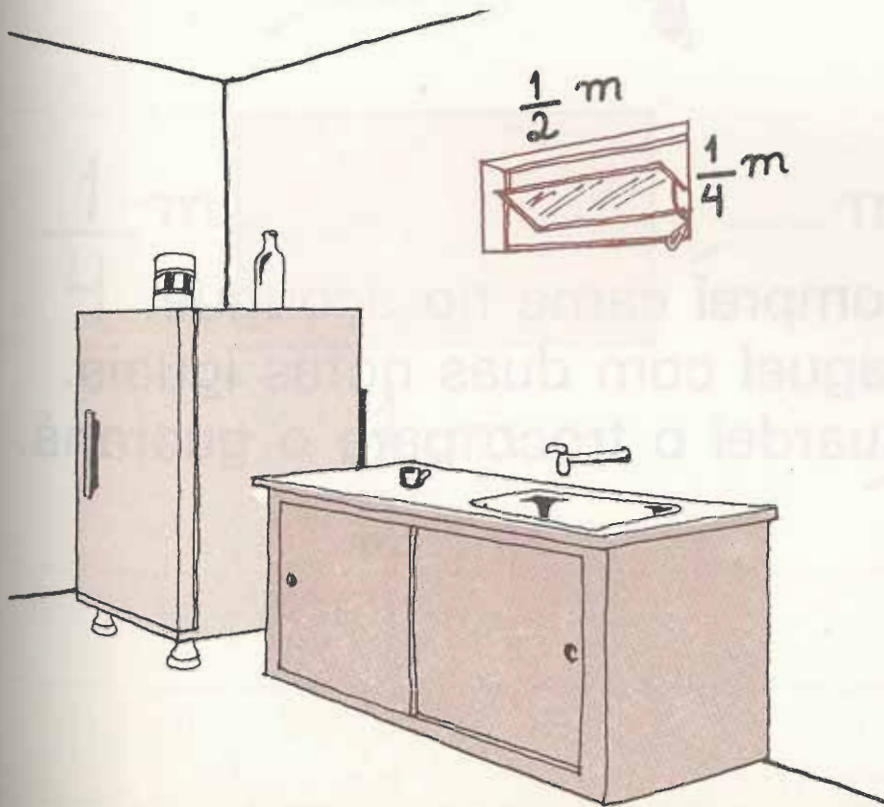

$\frac{1}{2} m$

$\frac{1}{4} m$

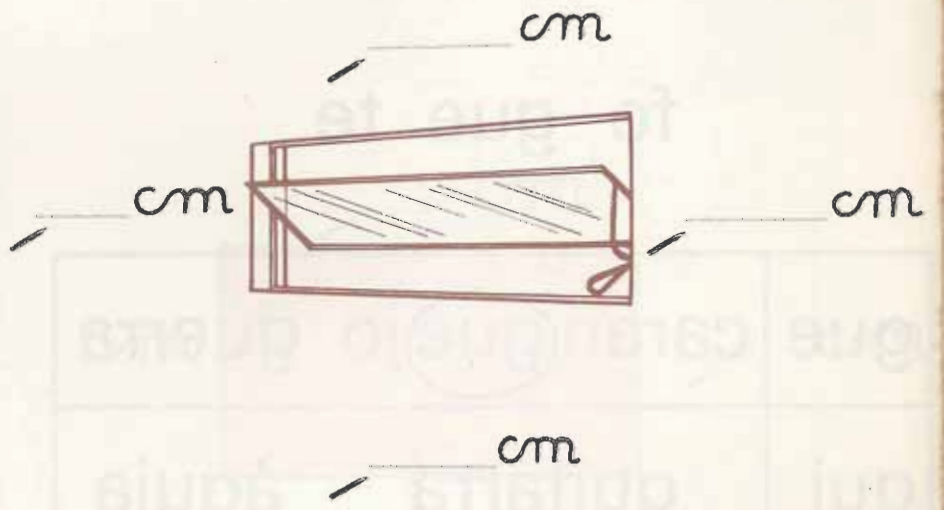

cm

cm

cm

cm



foguete

fo gue te

gue	caran <u>gue</u> jo	guerra
gui	guitarra	águia
gua	língua	égua



ré gua

a çou gue



gua ra ná

Comprei carne no açougue.
 Paguei com duas notas iguais.
 Guardei o troco para o guaraná.

$$\frac{1}{2} \text{ m} = \text{_____ cm}$$

$$\frac{1}{4} \text{ m} = \text{_____ cm}$$

_____ m



_____ m
 $\frac{1}{2}$

_____ m

_____ cm

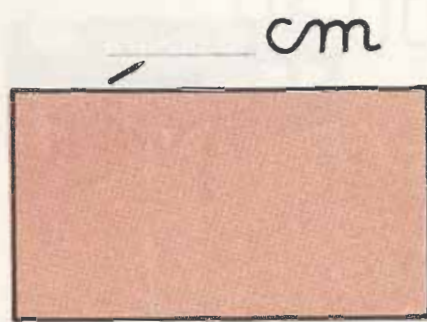

_____ cm

_____ cm

hospital 

 **limpeza**

foguete 



pesado

foguista

zelador

honrado

exame de sangue

O foguista lida com máquinas.
Ele faz exame de sangue.
Ele é cuidadoso com a saúde.

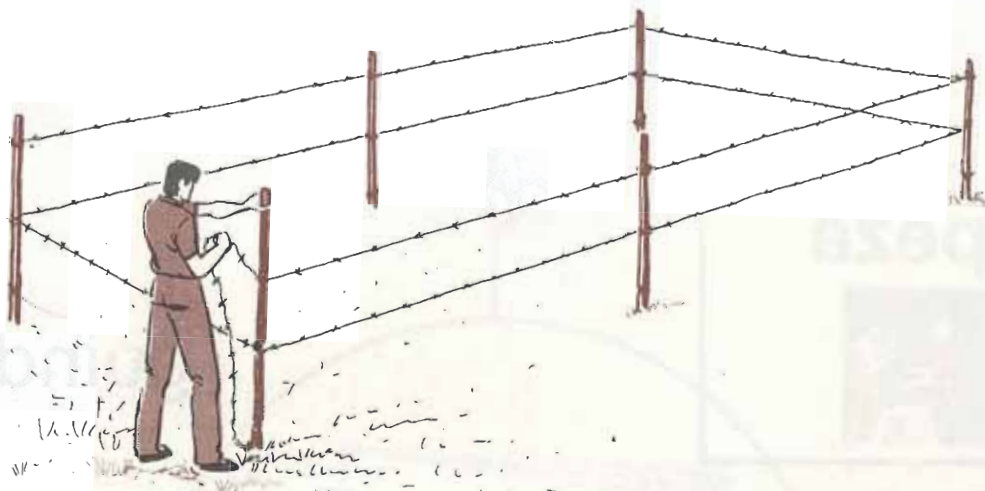

$$\begin{array}{r} 16 \\ \times 2 \\ \hline \end{array}$$

$$\begin{array}{r} 32 \\ \times 3,00 \\ \hline \end{array}$$

96,00

4

hospital 

 **limpeza**

foguete 



tesoura



caranguejo

guindaste



rosas

Terminou o horário de serviço.
É preciso guardar o guindaste.
A máquina fica com o zelador.

águia



$$\begin{array}{r} 27 \\ \times 3 \\ \hline \end{array}$$

$$87 \overline{) 3}$$

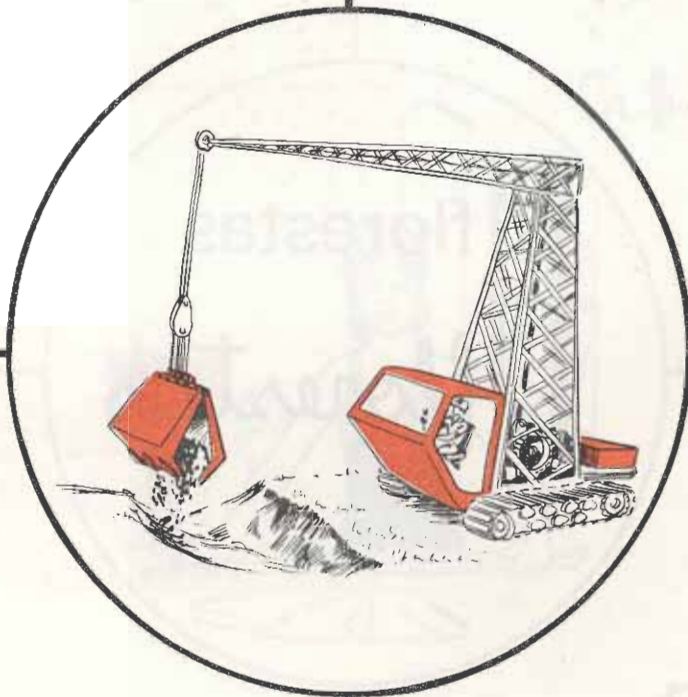

$$\begin{array}{r} 14 \\ \times 5 \\ \hline \end{array}$$

$$72 \overline{) 6}$$



plástico

plástico

clima

clima



florestas

plantas

florestas

plantas

placa	aflito
clima	blusa
globo	atleta

O clima das florestas é agradável.
As plantas purificam o ar.
A maior floresta é a Amazônica.
Ela fica ao norte do Brasil.

$$\begin{array}{r} 23,00 \\ \times 3 \\ \hline \end{array}$$

$$3 \times \text{Cr} \$ 23,00 =$$

$$\begin{array}{r} 80,00 \\ - 72,00 \\ \hline \end{array}$$

$$\text{Cr} \$ 80,00 - \text{Cr} \$ 72,00 =$$



$$\begin{array}{r} 69,00 \\ + 3,00 \\ \hline \end{array}$$

$$\text{Cr} \$ 69,00 + \text{Cr} \$ 3,00 =$$

$$\begin{array}{r} 45,00 \\ \times 2 \\ \hline \end{array}$$

$$2 \times \text{Cr} \$ 45,00 =$$

lucro

prejuízo



plástico

plástico

plástico



globo



diploma



flores



bicicleta

O curso está quase completo.
Vou receber o diploma.
Levarei flores para a professora.

Comprei:



Cr\$ 15,00



Cr\$ 12,00

Gastei: Cr\$ _____

Paguei com:



Troco: Cr\$ _____

Comprei:

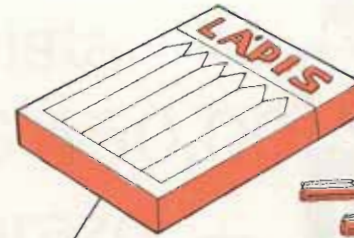

Cr\$ 18,00

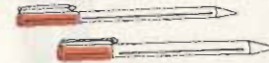

Cr\$ 13,00

Vendi por: Cr\$ 25,00

Tive:

lucro

prejuízo

De quanto? Cr\$ _____

fábrica de plástico

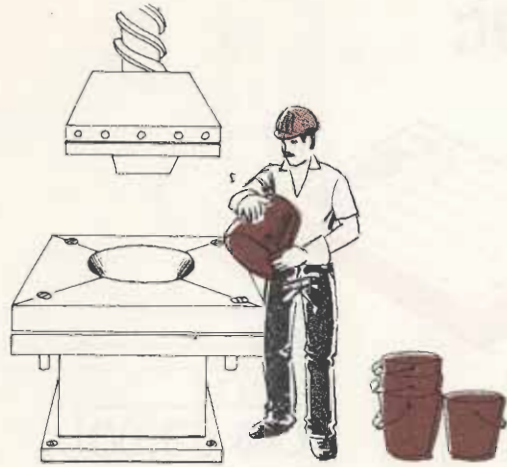

emblema de plástico

plástico

pli
fle
cla
blu
gle

flecha
gleba
Plínio
claro
blusa

RECIBO

Receb _____ do Sr. _____

a quantia de Cr\$ _____

referente _____

_____ de _____ de 19 _____

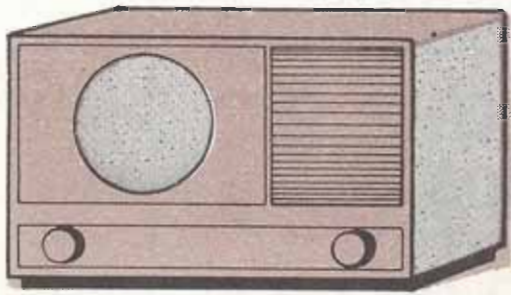

É barato mesmo!

À vista

Cr\$ 450,00

A prazo

5 x Cr\$ 99,00

99,00

×5

495,00

-450,00

5 × Cr\$ 99,00 =

Cr\$ 495,00 - Cr\$ 450,00 =



cla ro
 ridade

flo COS
 resta

plástico

plástico

plástico

fábrica de

Na aula de hoje você aprendeu:
a ler e a completar um recibo.



Comprem aqui!

À vista

Cr\$ 300,00

A prazo

4 x Cr\$ 83,00

$$\begin{array}{r} 332,00 \\ - 300,00 \\ \hline \end{array}$$

$$\begin{array}{r} 83,00 \\ \times 4 \\ \hline \end{array}$$

$$\text{Cr\$ } 332,00 - \text{Cr\$ } 300,00 =$$

$$4 \times \text{Cr\$ } 83,00 =$$

Gastei mais

do que se tivesse comprado
à vista.

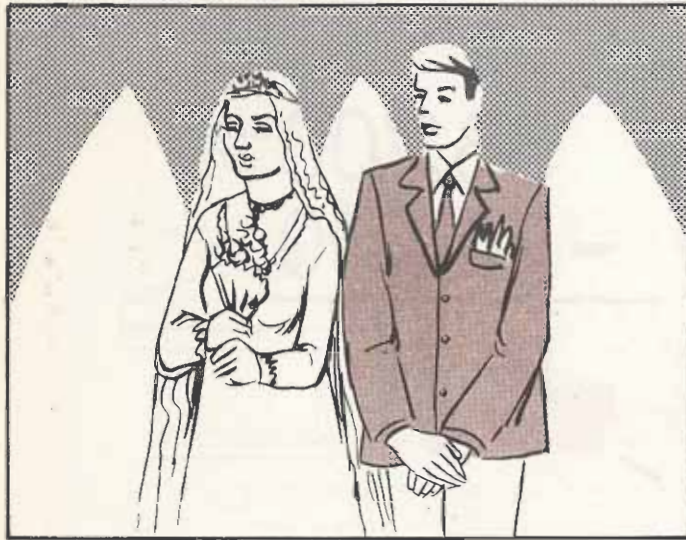

união

união

botão mamãe

mamão

anã

maçã

certidão

amanhã

4 de dezembro de 1978.

Fui ao Cartório de Registro Civil, onde você foi registrada quando nasceu, para pedir uma cópia da sua _____ de nascimento.

Somente amanhã poderei fazer chegar até você.

Um abraço do seu _____

Armazém Céu Azul
Rua das Araras, n.º 19 — Timbaúba

Data da emissão ____/____/19____

Quantidade	Discriminação das mercadorias	Preço unitário	Total
2 m	tecido	Cr\$32,00	Cr\$
$\frac{1}{2}$ m	renda	Cr\$24,00	Cr\$
3 m	fita	Cr\$5,00	Cr\$
Total:			Cr\$

$$\begin{array}{r} 32,00 \quad 24,00 \quad | \quad 2 \\ \times \quad 2 \\ \hline \end{array}$$

$$\begin{array}{r} 64,00 \\ 12,00 \\ + 15,00 \\ \hline \end{array}$$

$$\begin{array}{r} 5,00 \\ \times \quad 3 \\ \hline \end{array}$$

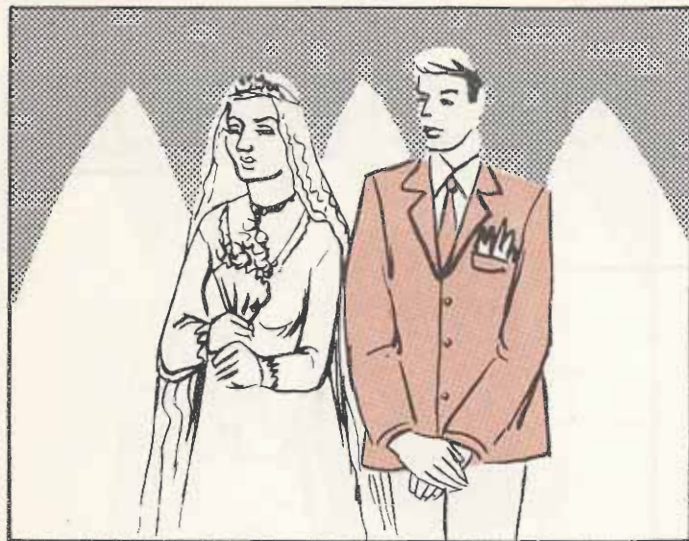

cida }
certi } dão

ave }
hortel } lã

união

u ni ão

união

hortelã cheirosa

Não esqueça sua certidão.
É um documento muito importante

não

Armazém Céu Azul
Rua das Araras, nº 19 – Timbaúba

Data da emissão ____/____/19____

Quantidade	Discriminação das mercadorias	Preço unitário	Total
3 kg	batata	G\$8,00	G\$
2 l	leite	G\$5,00	G\$
1/2 kg	café	G\$64,00	G\$
Total:			G\$

$$\begin{array}{r} 8,00 \\ \times 3 \\ \hline \end{array}$$

$$\begin{array}{r} 5,00 \\ \times 2 \\ \hline \end{array}$$

$$\begin{array}{r} 64,00 \mid 2 \\ \hline 24,00 \\ 10,00 \\ + 32,00 \\ \hline \end{array}$$



união

canção canções

mãe mães

pão pães

mão mãos

irmã irmãs

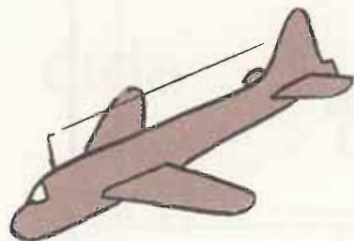

avião

aviões



VIA AEREA
PAR AVION.

Rua _____
Estado de _____
CEP _____

Remetente: _____

Endereço: Rua Araucária, nº 19
CEP: _____ Estado do Rio de Janeiro

saída



chegada

duração
da viagem



Blank lines for writing the duration of the trip for each cyclist.



união

balão





ba



pião

pi

 coração

 corações

 mão

 mãos

profissão: tecelão

Qualquer profissão é importante.
Valorize a sua.

Qualquer

saída
Rio de Janeiro



duração
da viagem



45 min

chegada
São Paulo

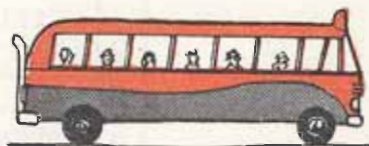



trabalho

trabalho

trabalho



folha



galho



milho

colheita

É preciso debulhar o milho.
Esse trabalho tem época certa.
Não perca sua colheita.

Comprei:



Cr\$ 5,20



Cr\$ 3,10



Cr\$ 1,60

Cr\$ 64,00



Paguei com:



Gastei:

Troco:



trabalho

melhor

palhoça



folhinha



bilhete

Ilhéus, 20 de _____ de 1978.

Prezado Jeremias

A encomenda feita, por você,
ao Fialho vai chegar segunda-feira.

Acho _____ preparar a _____
para armazenar o _____

Marque na _____ para você
não esquecer.

Abraços

Ramalho

Nº	025 649930	01 0.711.286-1 CPF 033397937-00	Nº	025 649930	Banco	C/S
Nome	Fialho	BANCA CAIXA DE DEPÓSITOS BOAVISTA		231		
Data		Pague por este cheque a quantia de	cento e seis cruzeiros			
Saldo em	Cr\$ 183,00					
Dep.	Cr\$ 35,00		Fialho on a ordem			
Dep.		AGENCIA PRAIA DE BOTAFUGO	de de 19			
Dep.		PRAIA DE BUTAFUGO, 428-A RJ				
Suma		Banco  Boavista S.A.	Jeremias Barbosa			
Ch.						
Saldo		004649930 0042340290 0000071128610				

Total

183,00
+ 35,00

Saldo

218,00
- 106,00



trabalho



bolhas

joelho



colher



folhinha

Complete o bilhete:

Olinda, _____ de _____ de 1978.

Querida _____

Recebi seu _____

Abraços

Tinha: Cr\$ 122,00

Depositei: Cr\$ 47,00

Retirei: Cr\$ 55,00

Faça as contas aqui



Nº	025 649931	01 0.711.206-1 CPF 033397937-00	Nº	025 649931	Banco	231	Cr\$
Pago a		0001000100 00100001000000000000					
Data		Pague por este cheque a quantia de _____					
Saldo ant.		a _____					ou à ordem
Dep.		AGENCIA PRAIA DE BOTAFOGO					de _____ de 19__
Dep.		PRAIA DE BOTAFOGO, 428-A RJ					
Soma		Banco  Boavista S.A.					
Ch.							
Saldo							



trabalho

tra ba lho



tra	ba	lha	dor
-----	----	-----	-----

serralharia

vergalhão

Você vai precisar para tirar sua Carteira de Trabalho:

- 2 (duas) fotografias com data atual;
- Certificado do Serviço Militar;
- Certidão de Casamento;
- Cópia da Certidão de Nascimento.

Não deixe de possuir sua carteira.

Ela é muito importante para você.

2 kg



Cr\$ 16,00 - kg

1/2 kg



Cr\$ 38,00 - kg

38,00

2

16,00

× 2

32,00

+ 19,00

Nº 025 649932

Pago a Mercado

Data

Saldo ant. Cr\$ 387,00

Dep.

Dep.

Dep.

Soma

CH

Saldo

01 0.954.853-6



Nº 025 557540 Banco Cr\$ 231

Pague por este cheque a quantia de

Cinqüenta e um cruzeiros

Mercado

ou a ordem

AGENCIA PRAIA DE BOTAFOGO
PRAIA DE BOTAFOGO, 42R-A RJ

Vitoria, 15 de agosto de 1978

Banco Boavista S.A.

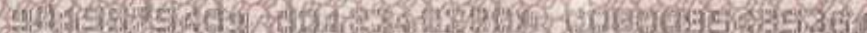



trabalho



Hoje cedo tratei dos documentos.

Já tirei minha Carteira de Trabalho.

lha	te <u>lha</u> do	muralha
lhe	bilhete	colhe
lhi	filhinha	velhice
lho	atalho	orvalho
lhu	orelhudo	silhueta

4 kg



Cr\$ 5,00 – kg

250 g



Cr\$ 60,00 – kg

1/2 kg



Cr\$ 58,00 – kg

Faça as contas aqui

Nº	025 649933	01 0.711.286-1 CPF 033397937-30	Nº	025 649933	Banco	Cr\$
Pago a	Quitanda da Ilha	AGENCIAS DE PAGAMENTO		231		
Data		Pague por este cheque a quantia de	_____			
Saldo ant.	Cr\$ 289,00		_____			
Dep.			_____			
Dep.			_____			
Dep.			_____			
Soma		AGENCIA PRAIA DE BUTAFUGO	Ilha Bela, de _____ de 19__			
Ch.		PRAIA DE BUTAFUGO, 428-A RJ				
Saldo		Banco Boavista S.A.				

plástico



união

trabalho



mutirão



muralha

trator com colhedeira

caminhões de areia



Aquele clube cresceu bastante.
Levantamos uma muralha.
Usamos vários caminhões de areia.



Cr\$ 495,00



$$\begin{array}{r} 88,00 \\ \times 4 \\ \hline 352,00 \end{array}$$

$$\begin{array}{r} 352,00 \\ + 93,00 \\ \hline 445,00 \end{array}$$

$$\begin{array}{r} 495,00 \\ - 445,00 \\ \hline 50,00 \end{array}$$

lucro

prejuízo

de

plástico



união

trabalho



construção

aparelho

trabalho completo

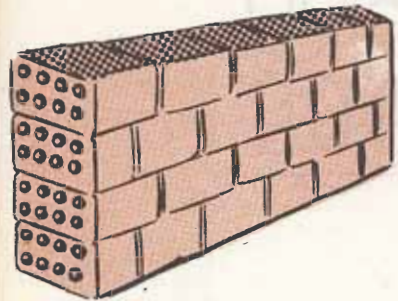

paredão

Fizemos um mutirão.

Levantamos uma muralha de pedras.

A construção foi difícil.

blusão



Comprei:



Cr\$ 343,00

Vendi por: $5 \times \text{Cr } \$73,00$

Recebi pela venda:

Tive:

lucro
prejuízo

de:

Comprei:



Cr\$ 45,60



Cr\$ 89,30

Gastei:

Paguei com:



Recebi de troco:



Isto foi o começo...
Você passou por várias etapas.

Já alcançou algo muito importante.

Você já sabe ler, escrever e calcular, mas ainda há muito mais...

Alguma coisa mais profunda, mais consciente.

Agora, você poderá participar mais e compreender melhor o mundo que o cerca.

A sua força de vontade o levará ao sucesso!

lendo



compreendendo

participando

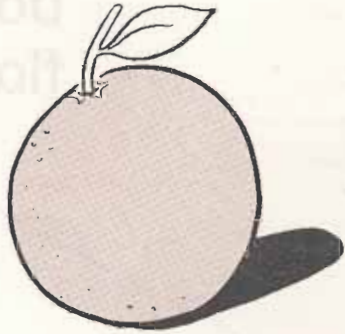
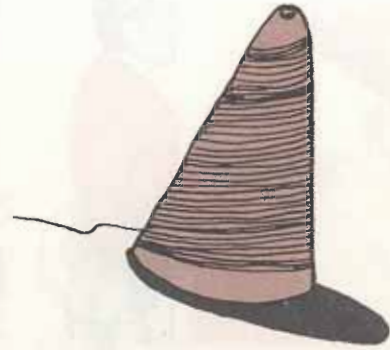



verão

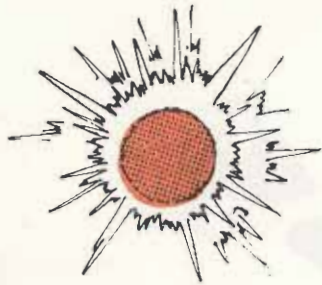

quente

flor



O verão

O verão chegou com toda sua beleza.

É tão quente que as matas começam a amarelar.

Os pássaros cantam e as borboletas voam de flor em flor.

Que maravilha de colorido!

Quem chegou com toda beleza?

Quem voa de flor em flor?

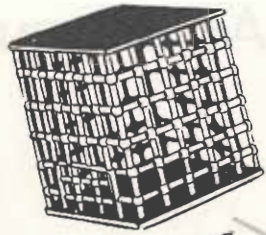



Escreva uma carta para um amigo, convidando-o para assistir ao encerramento do programa do MOBRAL da sua cidade.

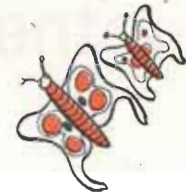

perguntas



Pis, 3 de Setembro de 1978.

Caro amigo, Carlos

Estoy escrevendo para você

para perguntar se você vai

al cinema comigo.

Eu gostaria de ir com você

e uma colega. Você porre

alunos lá? /

assinatura

Elvira Betânia

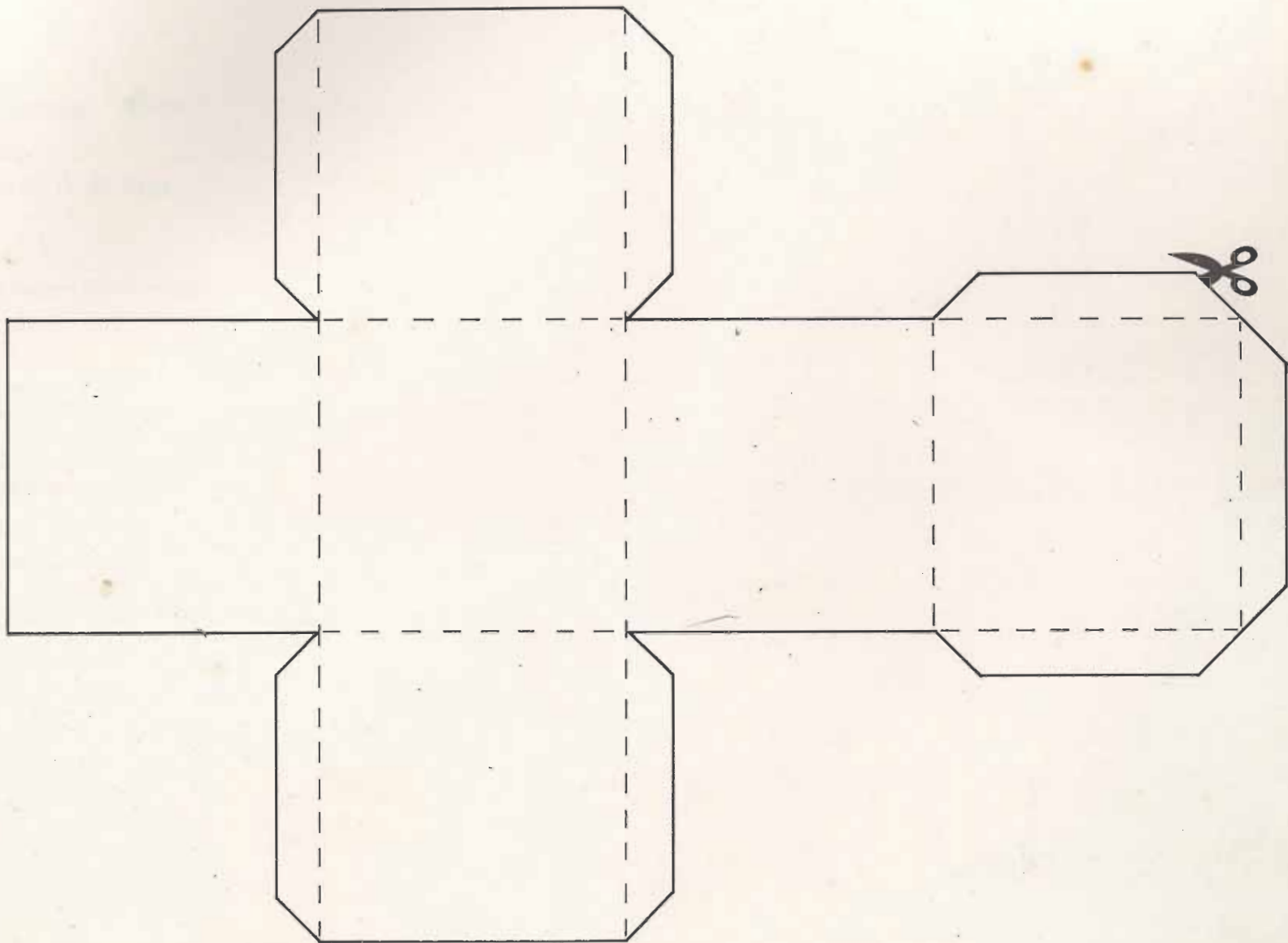

AUTORIA

Gerência Pedagógica – GEPED

ELABORAÇÃO

Carmen Lydia Ely de Sá Freire
Sonia Kritz

SUPERVISÃO

Adélia Maria Nehme Simão e Koff
Suzana Kaz

AVALIAÇÃO

Alfredo Fontes
Heloisa Meira Coelho Melhado
Maria Leonor de Macedo Soares Leal
Marília Scofano de Souza Aguiar
Vera Lucia Borges Leão

ILUSTRAÇÃO

Everaldo P. da Silva Junior
Miro
Sidney Francisco Batista da Silva

PROGRAMAÇÃO VISUAL

Alfredo Fontes
Bernardino Netto
Heliane Gaubert
Hinedi Geluda Liberman
Paulo Roberto Mendo
Ronaldo Fróes

REVISÃO

Christina Maria Nehme Simão



MINISTÉRIO DA EDUCAÇÃO E CULTURA — MEC
FUNDAÇÃO MOVIMENTO BRASILEIRO DE ALFABETIZAÇÃO